

# TOSHIBA

## OWNER'S MANUAL

---

32V35KP / 32E35KP

43V35KP / 43E35KP

### **Owner's Record**

You will find the model number and serial number on the back of the TV. Record these numbers in the spaces provided below. Refer to them whenever you call upon your Toshiba dealer regarding this product.

**Model number:**

**Serial number:**

ES-A21080Z-1

# Contents

## Welcome to Toshiba

- Thank you for purchasing this Toshiba LED TV. This manual will help you use the exciting features of your new TV.
- Instructions in this manual are based on using the remote control.
- Please read all safety and operating instructions in this manual carefully, and keep this manual for future reference.
- LED TV is LCD Panel with LED Backlight.

## Contents

|  |           |
|--|-----------|
| <b>Content</b> .....                             | <b>1</b>  |
| <b>Important Safety Precautions</b> .....        | <b>2</b>  |
| <b>Getting started</b> .....                     | <b>5</b>  |
| Accessories List .....                           | 5         |
| Installing the Stand or Wall mount bracket.....  | 5         |
| TV Front.....                                    | 6         |
| TV Rear .....                                    | 7         |
| Installing the P-Clip.....                       | 8         |
| Terminals .....                                  | 9         |
| Wired Setup.....                                 | 10        |
| Wireless Setup .....                             | 10        |
| Connecting with an HDMI(ARC) Cable.....          | 10        |
| Connecting with an HDMI Cable .....              | 10        |
| Connecting with an USB Cable .....               | 10        |
| <b>Remote Control</b> .....                      | <b>11</b> |
| Buttons on the Remote Control .....              | 11        |
| Installing Batteries in the Remote Control ..... | 12        |
| Pairing the Remote Control .....                 | 12        |
| Voice search function.....                       | 12        |
| Remote Control Operation Range.....              | 12        |
| <b>General Operation</b> .....                   | <b>13</b> |
| Turning your TV on or off.....                   | 13        |
| Selecting the Input Source .....                 | 13        |
| Using the Live TV .....                          | 13        |
| Using the Menu Function.....                     | 13        |
| EPG.....   | 14        |
| PVR.....   | 14        |
| T.Shift .....                                    | 14        |
| <b>Settings</b> .....                            | <b>15</b> |
| Using the Settings.....                          | 15        |
| Device Preferences.....                          | 16        |
| <b>Smart Functions</b> .....                     | <b>19</b> |

|                                |           |
|--------------------------------|-----------|
| Home .....                     | 19        |
| Media .....                    | 19        |
| <b>Troubleshooting</b> .....   | <b>20</b> |
| Self Diagnosis.....            | 20        |
| <b>Other Information</b> ..... | <b>21</b> |
| Specifications.....            | 21        |
| Media Format List.....         | 22        |
| License Information.....       | 24        |

### Disclaimer:

Images throughout this document are for illustrative purposes only and may differ from the actual product.

Designs and specifications are subject to change without notice.

# Important Safety Precautions

Be sure to observe the following instructions and precautions to ensure safe use of this TV.

## Installation

- WARNING: To prevent injury, this apparatus must be securely attached to a stable surface/wall in accordance with the installation instructions.**

### Install the TV in a horizontal, stable location.

- If the TV is not installed securely, it may lean or fall over and cause an injury.
- To prevent injury, use the exclusive optional stand or wall-hanging bracket to install this TV on a stable surface or wall securely in accordance with a qualified technician
- To secure the TV, use a sturdy strap from the hook(s) on the rear of the TV to a wall stud, pillar, or other immovable structure. Make sure the strap is tight, secure, and parallel to the floor.

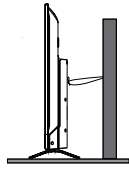

Only for the model with P-clip

- Never place the TV in an unstabilized location such as on a shaky table, incline or location subject to vibration.**

- Only use cabinets or stands recommended by the TV manufacturer.
- Only use furniture that can safely support the TV.
- Ensure that the TV is not hanging over the edge of the supporting furniture.
- Never place the TV on tall furniture (for example, cupboards or bookcases) without anchoring both the furniture and the TV to a suitable support.
- Never stand the TV on cloth or other material placed between the TV and supporting furniture.

The TV may drop or fall off, which may cause an injury or damage.

- Never stand or climb on the TV.**

- Educate children about the dangers of climbing on furniture to reach the TV or its controls.

Be especially careful in households with children to prevent them through climbing on top of the TV. It may move, fall over, break, become damaged or cause an injury.

- Always connect the power plug to an appropriate electrical outlet equipped with 100-240V AC, 50/60Hz.**

Never use the TV outside the specified voltage range. It may cause a fire or an electric shock.

### About the fuse

In a three pin earthing-type, the fuse fitted in this plug is approved by ASTA or BSI to BS1362. It should only be replaced by a correctly rated and approved type and the fuse cover must be refitted.

### About the use

- Make sure to insert the plugs firmly, when plugging the AC power cord into the TV set end and wall outlet end.
- Make sure to hold the plug, when unplugging the AC power cord.
- Never use other cord except for supplied AC power cord, and never use the supplied power cord for any other purpose.

- Never insert or remove the power plug with wet hands.**

This may cause an electric shock.

- Never block or cover the slots and openings in the cabinet.**

- Never place the TV so that it is facing upward or on its side.

- Never place the TV in a closet, bookcase or other similar area where the ventilation is poor.
- Never drape a newspaper, tablecloth or curtain on the TV.
- When installing the TV against a wall, always keep the TV at least 10cm away from the wall.
- Never place the TV on a soft unstable surface, such as a carpet, or a cushion.

The inside of this TV will overheat if the ventilation holes are covered, blocked or sealed, which may result in a fire.

- Never place the TV near a heater or in direct sunlight.**

The surface of the cabinet or power cord may melt and result in a fire or an electric shock.

- Never place the TV in an area exposed to high humidity levels, such as in a bathroom or close to a humidifier.**

This may cause a fire or an electric shock.

- Never place the TV next to a stove where it will be exposed to oil, smoke, or steam, or in a location where there is a large quantity of dust.**

This may cause a fire or an electric shock.

- Precautions for moving the TV.**

- When moving the TV, be sure to remove the plug from the wall outlet and disconnect the aerial cable and audio/video cables, any steady ties and mounting screw. A fire or an electric shock may result if the power cord is damaged.

- When carrying the TV, at least two people are needed. Be sure to carry it upright.

- Never carry the TV with the screen facing up or down.

- Precautions for installing on outdoor aerial.**

An outside aerial system should not be located in the vicinity of overhead power lines, or other electric light or power circuits.

If the aerial falls down or drops, it may cause an injury or an electric shock.

## Use

- Never place hot objects or open flame sources, such as lighted candles or nightlights, on or close to the TV.**

High temperatures can melt plastic and lead to fires.

- The apparatus shall not be exposed to dripping or splashing and that no objects filled with liquids, such as vases, shall be placed on the apparatus.**

When liquids are spilled or small items are dropped inside the TV, this may cause a fire or an electric shock.

If small objects drop inside the TV, turn off the TV and remove the power plug from the outlet immediately and contact a service technician.

- Never insert objects (metal or paper) or pour water inside the TV through ventilation holes and other openings.**

These items may cause a fire or an electric shock. If these objects are inserted inside the TV, turn off the TV and remove the power plug from the outlet immediately and contact a service technician. Be especially careful that children do not insert objects in the TV.

- When the TV will not be used for a long period of time, such as during vacation or travel, remove the power plug from the**

# Important Safety Precautions

## wall outlet for safety.

The TV is not completely disconnected from the power supply line, as minute current is consumed even when the Power switch is turned off.

The Mains plug or an appliance coupler is used as the disconnect device, therefore the disconnect device shall remain readily operable.

### 5. Never pull on the power cord when removing the plug from the wall outlet.

Always hold the plug firmly when removing it. If the power cord is yanked, the cord may become damaged and a fire or an electric shock may occur.

### 6. Never cut, break, modify, twist, bunch up or bent the cord or apply excessive force or tension to it.

Never place heavy objects on the cord or allow it to overheat as this may cause damage, a fire or an electric shock. Contact a service technician if the power cord is damaged.

### 7. If there is thunder or lightning, never touch the aerial cable or other connected cables.

You may suffer an electric shock.

### 8. Turn off the TV before unplugging the power cord.

Failure to do so, may cause a malfunction.

### 9. Listening to music at high volume levels and for extended durations can damage one's hearing.

In order to reduce the risk of damage to hearing, one should lower the volume to a safe, comfortable level, and reduce the amount of time listening at high levels.

### 10. In dry environment due to static electricity, the product may be restart and return to the main OSD interface, USB player interface or the previous source mode.

You can continue to use the TV when appear this phenomenon.

## Service

### 1. Never repair, modify or disassemble the TV by yourself.

It may cause a fire or an electric shock.

Consult a service technician for inspection and repairs.

### 2. When a malfunction occurs, or if smoke or an unusual odor comes from the TV, turn off the TV and remove the power plug from the outlet immediately.

Make sure that the smoke or smell has stopped, then contact a service technician. If the TV is still used in this condition, it may cause a fire or an electric shock.

### 3. If the TV is dropped or the cabinet is broken, turn off the TV and remove the power plug from the outlet immediately.

If the TV has power in this condition, it may cause a fire or an electric shock. If the cabinet is broken, be careful when handling the TV to prevent an injury.

Contact a service technician for inspection and repair.

### 4. When the TV reaches the end of its useful life, ask a qualified service technician to properly dispose of the TV.

## Cleaning

**CAUTION: Avoid using chemicals (such as air refreshers, cleaning agents, etc.) on or near the TV pedestal. Studies indicate that plastics may weaken and crack over time from the combination effects of chemical agents and mechanical stress (such as weight of TV). Failure to follow these instructions could result in serious injury and/or permanent damage to TV and TV pedestal.**

### 1. Remove the power plug before cleaning.

Never use solvents such as benzine or thinner to clean the TV.

- These solvents may distort the cabinet or damage its finish.
- If rubber or vinyl products remain in contact with the TV for a long time, a stain may result.

If the cabinet becomes dirty, clean it with a soft, dry cloth.

When cleaning the surface of the LED display, wipe the panel surface gently with a soft, dry cloth.

### 2. Periodically disconnect the power plug from the outlet and check it.

**If dust has collected on the power plug connectors, clean off the dust with a dry cloth.**

This dust may cause a fire due to reduced insulation on the plug.

## Important information

### 1. About LCD screen

- If you have the LCD screen facing to the sun, the LCD screen will be damaged. Be aware of locating the TV close to a window or outdoors.
- Never press the LCD screen strongly or scratch it, and never put anything on it. These actions will damage the LCD screen.

### 2. About cabinet and LCD screen

Never spray volatile compounds such as insecticide on the cabinet and LCD screen. This may cause a discoloration or damage the cabinet and LCD screen.

### 3. About afterimage

If a still picture is displayed, an afterimage may remain on the screen, however it will disappear. This is not a sign of malfunction.

### 4. Some pixels of the screen do not light up

The LCD display panel is manufactured using an extremely high level of precision technology, however sometimes some pixels of the screen may be missing picture elements or have luminous spots. This is not sign of malfunction.

### 5. About Interference

The LCD display may cause interference in image, sound, etc. of other electronic equipment that receives electromagnetic waves (e.g. AM radios and video equipment).

### 6. About using under the low temperature places

If you use the TV in the room of 0°C or less, the picture brightness may vary until the LCD monitor warms up. This is not a sign of malfunction.

### 7. When disposing of or transferring ownership of the TV

Before disposing of or transferring ownership of the TV, perform "Resetting the TV".

# Important Safety Precautions

## Recording using an USB storage device

- Be sure to select the correct country/region for use.  
Use of the recording function may not be possible depending on the selected country/region.  
Use with incorrect settings may violate certain laws or other regulations, and may result in criminal punishment.  
In such cases, Toshiba corporation and the Toshiba Group shall bear no responsibility whatsoever.
- The recording function has been designed for private use and entertainment in your home environment.  
Please note that any commercial use of the recording function could lead to copyright infringement of authors' rights. Toshiba asks you to respect the intellectual property rights of third parties.
- Before recording to a device connected to the TV, make a test recording and check the recording performance.
- Toshiba shall not be liable for compensation or incidental damages of any kind whatsoever resulting from content that was not properly recorded on the recording device or that was modified or lost.
- Toshiba shall not be liable for damages of any kind whatsoever (breakdown of the recording device, modification or loss of the recorded content, etc.) resulting from malfunction, operating failure or incorrect operation due to combining with another connected device.
- Do not turn off the power supply to the USB storage device or disconnect the connecting cable while the USB storage device is operating. Doing so may result in loss of the recorded data or malfunction of the USB storage device.
- The recording function is not available in all countries/regions.
- Please note that recording on the USB storage device is no longer playable after the TV's main-board is exchanged during service.
- If the time information is incorrect, programed recording may not be performed properly.  
Furthermore, if the time information differs according to the currently viewed channel, programed recording may not be performed properly depending on tuning operations.

## Exemptions

- Toshiba is not liable for any damage caused by fires, natural disaster (such as thunder, earthquake, etc.), acts by third parties, accidents, owner's misuse, or uses in other improper conditions.
- Toshiba is not liable for incidental damaged (such as profit loss or interruption in business, modification or erasure of record data, etc.) caused by use or inability to use of product.
- Toshiba is not liable for any damage caused by neglect of the instructions described in the owner's manual.
- Toshiba is not liable for any damage caused by misuse or malfunction through simultaneous use of this product and the connected equipment.

## When using a wireless network

### CAUTION:

- Bluetooth™ and Wireless LAN devices operate within the same radio frequency range and may interfere with one another. If you use Bluetooth™ and Wireless LAN devices simultaneously, you may occasionally experience a less than optimal network performance or even lose your network connection.

- If you should experience any such problem, immediately turn off either your Bluetooth™ or Wireless LAN device.
- Actual performance can vary, including lower wireless network capacity, data throughput rate, range and coverage.
- Performance depends on many factors, conditions and variables, including distance from the access point, volume of network traffic, building materials and construction, operating system used, mix of wireless products used, interference and other adverse conditions.

## Wireless LAN and your Health

Wireless LAN products, like other radio devices, emit radio frequency electromagnetic energy. The level of energy emitted by Wireless LAN devices, however, is far less than the electromagnetic energy emitted by wireless devices such as mobile phones.

Because Wireless LAN products operate within the guidelines found in radio frequency safety standards and recommendations, Toshiba believes Wireless LAN is safe for use by consumers. These standards and recommendation reflect the consensus of the scientific community and result from deliberations of panels and committees of scientists who continually review and interpret the extensive research literature.

In some situation or environments, the use of Wireless LAN may be restricted by the proprietor of the building or responsible representatives of the organization. Such restrictions may apply in environments where the risk of interference to other devices or services is perceived or identified as harmful.

If you are uncertain of the policy that applies to the use of wireless devices in a specific organization or environment, you are encouraged to ask for authorization to use the Wireless LAN device prior to turning on the equipment.



This equipment is a Class II or double insulated electrical appliance.

It has been designed in such a way that it does not require a safety connection to electrical earth.

 AC voltage: This symbol indicates that the rated voltage marked with the symbol is AC voltage.



- This lightning flash with arrowhead symbol within an equilateral triangle is intended to alert the user to the presence of non-insulated "dangerous voltage" within the product's enclosure that may be of sufficient magnitude to constitute a risk of electric shock.
- Warning: To reduce the risk of electric shock, do not remove cover (or back) as there are no user serviceable parts inside. Refer servicing to qualified personnel.
- The exclamation point within an equilateral triangle is intended to alert the user to the presence of important operating and maintenance instructions in the literature accompanying the appliance.

# Getting started

## Accessories List

The following accessories are included with TV:

OWNER'S MANUAL × 1  
Base Stand × 2  
AAA Battery × 2

Remote Control × 1  
Screw × 4

Optional, some countries/regions may not have: P-Clip × 1 (with 1 screw M6×12 and 1 screw ST4×25C)

### NOTE

- The accessories may be different from the list above due to different models, countries/regions, please refer to the actual accessory bag.

## Installing the Stand or Wall mount bracket

### Installing the Stand

#### CAUTION

- Be sure to disconnect the A/C power cord before installing a stand or Wall-Mount brackets.
  - The LED display is very fragile, and must be protected at all times when installing the base stand. Be sure that no hard or sharp object, or anything that could scratch or damage the LED display, comes into contact with it. DO NOT exert pressure on the front of the TV at any time because the screen could crack.
  - After the installation is complete, make sure the TV is steady on a table or firmly attached to a wall mount, before removing all protective film, if any.
- Carefully place your TV face-down on a soft, flat surface to prevent damage to the TV or scratching to the screen.
  - Remove the Base Stand from the accessory bag and then insert the stands into the bottom slots of the TV.
  - Secure the Base Stand to the TV with the screws in accessory tightly.

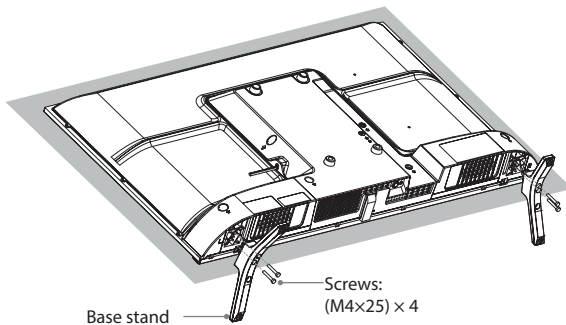

### Installing the Wall Mount Bracket

Before mounting the TV, remove the TV stand if you have already attached it, and make sure the wall mount bracket supports the weight of your TV.

#### CAUTION

When mounting the TV on a wall, follow instructions provided with the wall mount bracket. If it is not correctly mounted, the TV may fall and cause property damage or personal injury.

- Place spacers between the TV and bracket.
- Make sure the tilt angle between the TV screen and the vertical surface is no more than 15 degrees.
- Standard dimensions are shown below.

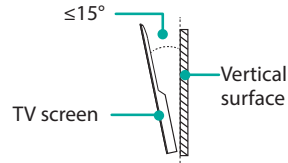

|                              |                                    |
|------------------------------|------------------------------------|
| Wall mount hole pattern (mm) | 100 × 200 (32")<br>200 × 200 (43") |
| Wall mount screw size (mm)   | M6                                 |

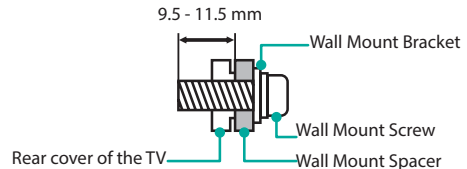

Follow instructions provided with the wall mount bracket.

#### NOTES

- The diameter and length of the screws differ depending on the wall mount bracket model.
- Wall mount bracket is optional, your device may not have wall mount bracket, please refer to the actual accessories.

# Getting started

## TV Front

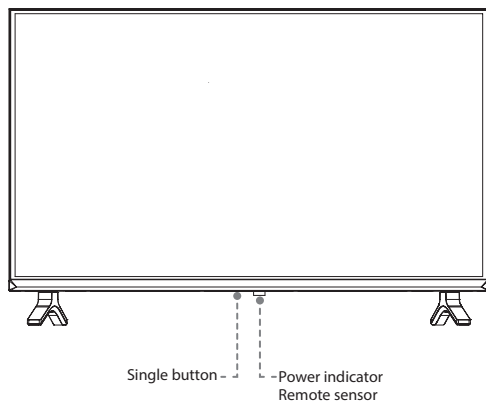

| <b>Item</b>  | <b>Description</b>   |
|--|--|
| <b>Remote sensor</b>   | Receive remote signals from the remote control.<br>Do not put anything near the sensor, as its function may be affected. |
| <b>Power indicator</b>   | The light is red in standby mode, the light is green when TV is on.  |
| <br><b>Standby</b> | Press the button to turn on / off the TV.  |

### NOTE

- Powering on the TV requires several seconds to load programmes. Do not rapidly turn the TV off as it may cause the TV work abnormally.

# Getting started

## TV Rear

32"  
(32V35KP/32E35KP)

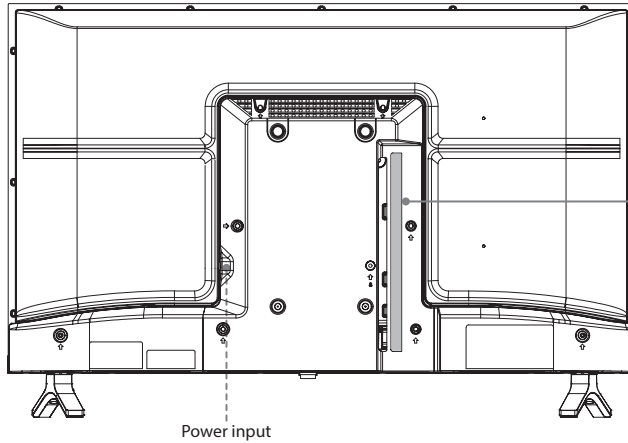

43"  
(43V35KP/43E35KP)

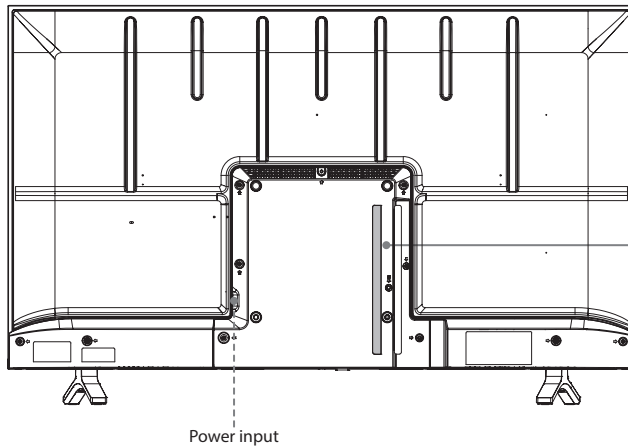

### NOTES

- The image is for reference only and may differ from actual product appearance.
- Check the jacks for position and type before making any connections. Loose connections can result in image or color problems. Make sure that all connections are tight and secure.
- Not all A/V devices have the ability to connect to a TV, please refer to the user's manual of your A/V device for compatibility and connections procedure.
- Before connecting external equipment, remove the mains plug from the wall socket. Otherwise, it may cause electric shock.



# Getting started

## Installing the P-Clip

Please fix the **A** part of the P-Clip with the M6 × 12 screw attached to the screw hole on the back of the TV set (marked in the illustration below).

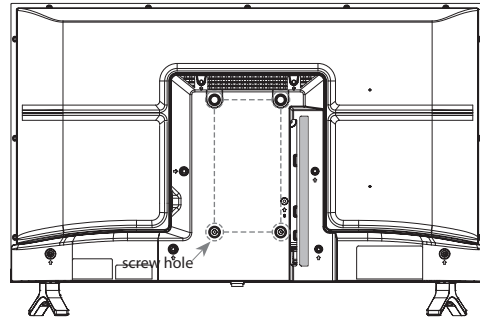
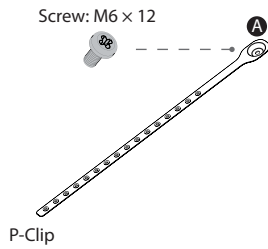

Select a suitable screw hole based on the actual situation

Select a suitable screw hole based on the actual situation, fix the **B** part of the the P-Clip on the wall or other places with the ST4 × 25C screw.

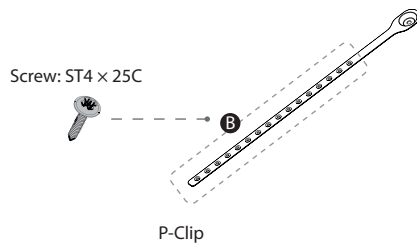











### NOTES

- Falling down of the product may cause personal injury or product failure.
- Fixed measures are recommended. If the method above can not fix the product, please consult the manufacturers.
- P-Clip is optional, your device may not have P-Clip, please refer to the actual accessories.

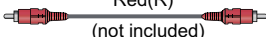
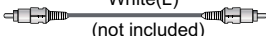
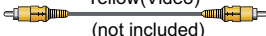
# Getting started

## Terminals

|                      |   |   |  |
|----------------------|---|---|--|
| ANT<br>DVB-T/T2/C    |    | Connect an outdoor VHF/UHF antenna.   |  |
| HDMI                 |    | Connect an HDMI cable from an external A/V equipment.   |  |
| HDMI(ARC)            |    | Connect an HDMI cable from an external digital audio system.  |  |
| VIDEO<br>INPUT       |  R<br> L<br> VIDEO |  Red(R)<br>(not included)<br> White(L)<br>(not included)<br> Yellow(Video)<br>(not included) | <p>Connect a composite video cable and left-right audio cables from an external AV device.</p> <p>The VIDEO can be used to connect a range of equipment, including video recorders, camcorders, decoders, satellite receivers, DVD players, or games consoles.</p> |
| USB                  |    | Connect a USB device for browsing photos, music and movies.   |  |
| DIGITAL<br>AUDIO OUT |    | Connect an optical cable from an external digital audio system.   |  |
| LAN                  |   | Connect an Ethernet cable to access a network or the Internet.  |  |
| HEADPHONE            |    | <p>Connect headphones to listen to the sound coming from the TV.</p> <p>Note: Excessive sound pressure from earphones can cause hearing loss.</p>   |  |

### NOTE

- The location and names of the terminals on the TV may vary according to TV model, and not all terminals available on all models.

# Getting started

## Wired Setup

Connect your TV to your network by connecting the LAN port on the back of your TV to an external modem or router using a LAN (Ethernet/Cat 5) cable.

See the illustration below.

### NOTES

- You get access to the Internet through your TV.
- We recommend to use a modem or router that supports Dynamic Host Configuration Protocol(DHCP). Modems and routers that support DHCP automatically provide the IP address, subnet mask, gateway, and DNS, so you don't have to enter them manually. Most home networks already have DHCP.

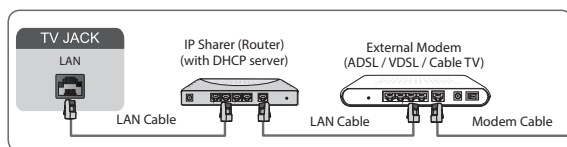

## Wireless Setup

Connect your TV to your wireless network, you need a wireless router or modem. See the illustration below.

The TV's built-in Wireless LAN Adapter supports the IEEE802.11 b/g/n communication protocols.

### NOTES

- You get access to the Internet through your TV.
- Connect to an available wireless network.
- Make sure that you have the wireless router's SSID and password before attempting to connect.

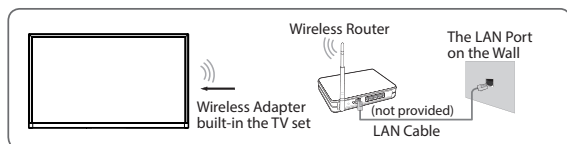

## Connecting with an HDMI(ARC) Cable

Connect an HDMI cable from an external digital audio system. ARC enables the TV to directly output the digital sound through an HDMI cable. Please note that it works only when the TV is connected to the audio receiver that supports the ARC (Audio Return Channel) function.

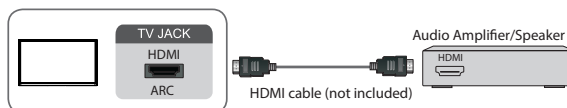

### NOTES

- When this port is used as the ARC function, it can be used as signal input when DVD is connected to amplifier and the amplifier is connected to the TV at the same time.(Some amplifiers may not support series connection.)
- ARC work by auto as per input ARC condition.

## Connecting with an HDMI Cable

Connect an HDMI cable from an external A/V equipment. Some devices such as DVD player require HDMI signal to be set to output in the device's settings. Please consult your device user manual for instructions. Please note that the HDMI connector provides both video and audio signals, it's not necessary to connect an audio cable.

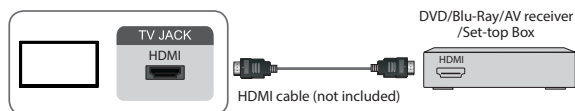

## Connecting with an USB Cable

Connect the USB devices such as hard drives, USB sticks and digital cameras for browsing photos, listening to music.

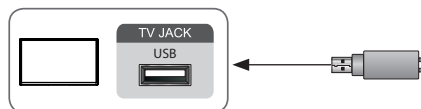

- Support the U disk 4G, 8G, 16G, 32G, 64G, 128G and other common market size, 2T hard drive is currently supported.
- Support format: NTFS, FAT32.

### NOTES

- NTFS does not support recording.
- The listed support formats may not function on some models.

## Using the USB storage device function

The USB storage device function can be used to record and view digital broadcast programmes.

Read the precautions below before recording or viewing programmes using the USB storage device function.

### NOTES

- Be sure to select the correct country/region for use.  
Use of the recording function may not be possible depending on the selected country/region.  
Use with incorrect settings may violate certain laws or other regulations, and may result in criminal punishment.  
In such cases, Toshiba corporation and the Toshiba Group shall bear no responsibility whatsoever.
- Recorded programmes saved on the USB storage device can only be viewed on this TV. They cannot be viewed when connected to another TV(including the same model of TV), a PC, or other device.
- You cannot watch one channel while recording another.
- If the recording time to the USB storage device is too short, no data may be saved.
- You cannot record video input signals on the USB device.
- Not all types of broadcast may be recordable.
- After programing the TV to record digital broadcasting, do not disconnect the power plug before recording starts.
- Should video or audio recording fail due to malfunction of the TV or poor reception, no compensation shall be paid.

# Remote Control

## Buttons on the Remote Control

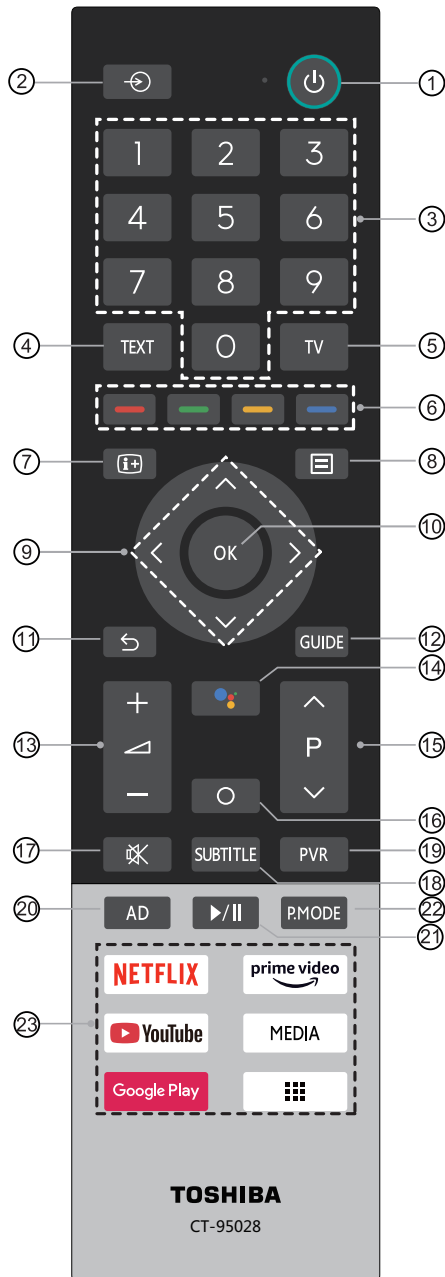

- ① POWER: Switch the TV on or into standby mode
  - ② : Select input source
  - ③ 0-9: Direct channel selection or numbers input
  - ④ TEXT: Turn on/off the teletext function
  - ⑤ TV: Enter the Live TV
  - ⑥ Red/Green/Yellow/Blue button: Color keys for direct selection of options
  - ⑦ : Display the current programme information
  - ⑧ : Setting Menu
  - ⑨ : Allows you to navigate the OSD menus and adjust the system settings to your preference
  - ⑩ OK: Confirm the selection in the OSD menus
  - ⑪ Back: Return to previous menu
  - ⑫ GUIDE: Display the Electronic Programme Guide (DTV mode)
  - ⑬ + / -: Adjust the volume
  - ⑭ Google assistant of TV
  - ⑮ P : Switch channel
  - ⑯ : Enter the Home screen
  - ⑰ : Mute or restore the TV sound
  - ⑱ SUBTITLE: Press to turn on/off Subtitle.
  - ⑲ PVR: Record the current programme(DTV mode)
  - ⑳ AD: Set the audio description on or off(The button is AD for Thailand area)
  - ㉑ Media content control function buttons
  - ㉒ P.MODE: Select picture mode
- NETFLIX: Press to launch NETFLIX instant video streaming  
 prime video:Enter the prime video app  
 YouTube: Enter the YouTube app  
 MEDIA: Enter the media  
 Google Play:Enter the Google Play app  
: Fast access to all applications
- ㉓

### NOTES

- The button information will vary depending on the remote control model.
- The Picture is Only for Reference. Check information according to the actual remote control in the accessory bag.

# Remote Control

## Installing Batteries in the Remote Control

### For CT-95028 Remote Control:

1. Slide the back cover to open the battery compartment of the remote control.
2. Insert two AAA size batteries. Make sure to match the (+) and (-) ends of the batteries with the (+) and (-) ends indicated in the battery compartment.
3. Close the battery compartment with the cover.

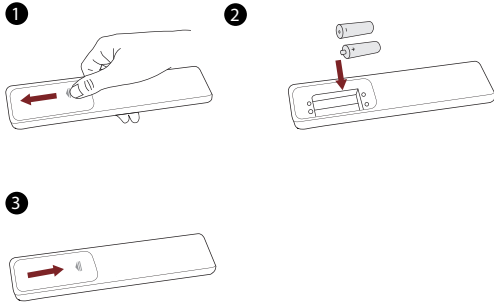

### NOTES

- Product image is only for reference, actual product may vary in appearance.

#### Handling the Batteries

- Incorrect use of batteries may cause corrosion or battery leakage, which could cause fire, personal injury or damage to property.
- Only use the battery type indicated in this manual.
- Do not mix old and new batteries or different types of batteries.
- Do not dispose of used batteries as domestic waste. Dispose of them in accordance with local regulations.
- Battery chemicals can cause a rash. If the batteries leak, clean the battery compartment with a cloth. If chemicals touch your skin, wash immediately.
- If you do not intend to use the remote control for a long time, remove the batteries.
- Remove depleted batteries immediately to prevent battery acid from leaking into the battery compartment.

## Pairing the Remote Control

Only available on certain models and bluetooth remote control.

1. Pair the remote to the TV after you power it on. Keep the remote control within 10 feet from the TV. Press and hold the menu button at least 3 seconds to start pairing.
2. If the remote paired successfully then a confirmation will display on the screen. If it did not pair successfully then an 'unsuccessful' message will display. Repeat the previous steps.

### NOTES

- If an unknown error occurred with the remote then it could have been caused by interference. Try to remove what's causing the interference and pair it again.
- If an unknown error occurred in the remote control while the battery power is normal, you can take out the batteries, press any key for 1~2 seconds, and insert them back. Then the remote control will work normally.
- The remote cannot be paired to the TV while the TV is in standby mode.

## Voice search function

- There is a voice search function in the upper left corner of the homepage.
- This function will be used by the apk of "Android TV" in your phone and the apk can be downloaded from Google play store.

## Remote Control Operation Range

The remote control can work at a distance of up to 8 meters in front of the TV set.

1. The remote control angle: taking the remote sensor as an apex, 6 meters away, its controlled horizontal angle is within  $\pm 30^\circ$ , while the vertical angle is within  $\pm 15^\circ$ .
2. The operating distance may vary depending on the brightness of the room.

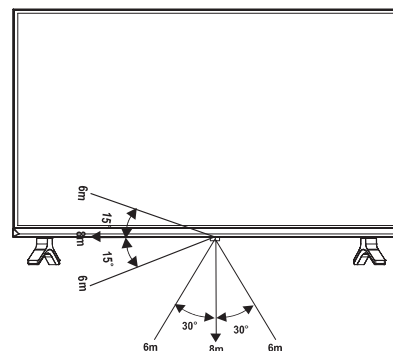

# General Operation

## Turning your TV on or off

To turn your TV on or off :

- 1 Plug the AC power cord into a socket outlet of AC power supply.
- 2 When the TV is powered on, press the [  ] button on the remote control, to turn TV on or off.



### NOTES

- When your TV is in standby mode, it is still consuming power. To completely disconnect power, please remove the mains plug from the mains socket.
- If your TV does not receive an input signal for several minutes, it automatically goes into standby mode.

## Selecting the Input Source

Select the Input Source depending on the video device you have connected to your TV.

### To select the input source:

- 1 Turn on your TV, then press the input source button on the remote, the list of Source appears.
- 2 Press the [  ] / [  ] / [  ] buttons to select the input source.
- 3 Press the [ **OK** ] button to confirm your selection.

## Using the Live TV

To view broadcast programs, press the home button on your remote, click the  Inputs icon in Home screen and select Channels as the input source.

### Channel scan guide

When you select **Channels** as input, if no TV channels were saved before, you will be prompted to do a channel scan. You can also go to **Settings > Channel** to change the channel settings.

### Viewing channel information

As you use the [  ] or [  ] button on your remote to switch channels, an information banner appears on the top of the screen.

### Viewing a channel list

After you have done an automatic channel scan (if you're using an antenna) or receiving your channels through a cable provider, you can view your list of channels by pressing [ **OK** ] button on your remote.



You will see the channel list display on the screen.

### Creating a Favorites List

To quickly access your most-watched channels, you can create a Favorites List.

To create your Favorites List:

- 1 Press the menu button on your remote to access the **Menu** in Channels source.

- 2 Press the [  ] / [  ] button to Channels and press [ **OK** ] button to add to my favorite.

### Viewing your Favorite list

To view channels that you've added to your Favorites List simply press [ **OK** ] button on your remote to call out the channel list.

The channel list appears on the screen. You can press the [ **blue** ] special button to view your favorite list.

## Using the Menu Function

Press the menu button on your remote to enter the **TV options** in TV mode.

### Picture Mode

Select a preset picture mode to best suit the content you're viewing. Then there are seven types of picture modes available: **User, Standard, Vivid, Sport, Movie, Game, and Energy Saving.**

### Display Mode

Adjust the Aspect Ratio to stretch or zoom in on your picture. You can choose from the following settings: **Automatic, Super zoom, 4:3, Movie expand 14:9, Movie expand 16:9, Wide screen, Full or Unscaled.**

### NOTES

- Using the special functions to change the size of the displayed image(e.g. changing the height/width ratio) for the purpose of public display or commercial gain may infringe on copyright laws.
- If the aspect ratio of the selected format is different from the one of the TV transmission or video programme, it can cause a difference in vision.
- When using PC connected via HDMI terminal, the moving image quality may be deteriorated.

### ARC

Select on or off. Select the TV speaker or an external speaker for sound output by Audio Return Channel.

### Power

Adjust the timer settings to suit your preference. You can set Sleep Timer, Picture off, Switch off Timer, No Signal Auto Power Off.

### Manual OAD Download

Update the software version by OAD.

### Advanced Options

You can set Blue Mute, MHEG PIN Protection, Subtitle, Teletext, Postal Code, Auto Sleep, System Information.

# General Operation

## Settings

Configure the TV. You can set Network & Internet, Channel, Accounts & Sign In, Apps, Device Preferences, Remotes & Accessories.

## EPG

It provides convenience to check TV programs that will be available in the next 8 days. The information displayed by the EPG is made available by the commercial television networks for digital channels only. (The availability and amount of program information will vary, depending on the particular broadcaster).

- Press the **[GUIDE]** button on the remote control to display channel information on program guide list.
- **Watch**  
When a current programme is selected, press **[OK]** button to watch.
- **Previous Day**  
Press **[RED]** button to go backward a day.
- **Next Day**  
Press **[GREEN]** button to move forwards a day.
- **Type Filter**  
Press **[BLUE]** button to indicate different genres in the Guide for quick and easy viewing.
- **Programme information**  
Press **[YELLOW]** button to view detail information of channel that be selected.

## PVR

The PVR function allows you to easily record digital television content for later viewing. The function is only available in DTV source. To use PVR, you must connect a USB device for recording. The PVR will not function if a data storage device has not been connected.

- **Schedule Recording**  
Press the **[GUIDE]** button, Select the program to be played, press **[PVR]** button to set the appointment time and period, the reservation is successful. Press the menu button on your remote, then select Schedule List to view the schedule recording by pressing **[▲]** / **[▼]** buttons on your remote. In the schedule list, you can readjust the reservation information that has been set.
- **Standby record**  
If you press the power button during recording, TV will go into standby mode but the recording process is still going on. If you press power button again and wake up the TV, recording process will not be affected. After recording, the recorded file will be automatically saved to the disk.
- **Record list**  
Viewing the recorded programs.  
Press the menu button on your remote, then select Record list by pressing **[▲]** / **[▼]** buttons on your remote. You can watch or delete recorded programs.

## NOTES

- The storage space of your USB device should be no less than 2G (for 15 minutes high definition video).
- If the transfer rate of your hard disk is too slow, a pop-up notice will appear, in this case, you can try another one.
- The PVR function doesn't support analogue channels.
- The schedule recording function is not available while you are watching a programme that is currently being broadcast.
- Some broadcasters may restrict to record the programme.
- During the recording progress, channels locked with Channel Lock(password needed) are disabled to watch.
- The PVR function is only applicable in some models/countries/regions.

## T.Shift

This option allows you to pause and rewind live TV. This function operates by recording temporarily to a storage device. Please ensure your storage device is connected and there is enough free disk space. Otherwise the recording will not commence.

Press the menu button on your remote, then select Time Shift Mode by pressing **[▲]** / **[▼]** buttons on your remote. Set Time Shift Mode on and then press the back button to return. Press **[II]** button to pause the live broadcast and press **[▶]** button to play. Press **[◀]** button to watch reverse and press **[▶▶]** button to watch advance playback rapidly. Press **[■]** button to exit the function and watch the current broadcast.

## NOTES

- The T.Shift function doesn't support analogue channels.
- The storage space of the USB device should be no less than 1G.
- The Timeshift function is only applicable in some models/countries/regions.

# Settings

## Using the Settings

- Press the home button on your remote to enter the Home screen, and then select the  icon to access the Settings menu. You can also press the menu button on your remote to enter the **Menu** in TV mode and then select the settings menu.

The **General Settings** menu consists of the following settings:

- **Network & Internet**
- **Channel**
- **Accounts & Sign In**
- **Apps**
- **Device Preferences**
- **Remotes & Accessories**

- In each menu, you can:

Press the [ / ] / [ / ] buttons to select an item.

Press the [**OK**] buttons to enter the sub-menu or to set on or off.

Press the [ / ] / [ / ] buttons to adjust the value.

Press the back button to return to the previous menu.

## Network & Internet

- **Wi-Fi**

Turn on the Wi-Fi to access the Internet via a wireless network connection.
- **See all / See fewer**

Press [**OK**] to view all available network or fewer.
- **Add new network**

You can add wireless network.
- **Scanning always available**

Check to scan for networks even when Wi-Fi is turned off.
- **Wow**

Wake on wireless network.
- **Wol**

Wake on LAN.
- **Connected / Not connected**

Show whether the Ethernet is connected.
- **Proxy settings**

You can set the proxy server.

 **NOTE**

HTTP proxy is used by the browser but may not be used by other apps.
- **IP settings**

Configure the IP setting for your network connection.

## Channel

- **Channels**

Set the channel scan, update scan, single RF scan, etc. according to your choice.
- **Channel Installation Mode**

Choose channel installation mode for Antenna, Satellite or Cable.
- **Auto Channel Update**

Allow your TV to auto-update the channel list from the content provider.
- **Parental Controls**

The Parental Controls setting allows you to block content that is not appropriate for children to watch.

  - **Channels Blocked**

Block programs by channels when you turn on the Parental Controls feature.
  - **Program Restrictions**

Certain programs are blocked when you activate the parental controls settings.
  - **Inputs Blocked**

Block content from devices that are connected to certain TV ports.
  - **Change PIN**

Change the PIN that you use to access Parental Controls.

 **NOTE**

If you forget your password, call the Consumer Electronics Care Center.
- **Audio channel**

Mono. (The feature is available on ATV mode.)
- **Audio Language**

Available on DTV mode to set the audio language.
- **Second Audio channel**

Available on DTV mode to set the second audio language.
- **Open Source Licenses**

Declaration of open source licenses.
- **Version**

The version of the channel.

## Accounts & Sign In

Make the most of your TV. Choose account type and sign in to get new apps, recommendations, movies and more.

## Apps

View details about an app or other item listed. The information and controls available vary among different types of apps.

## Device Preferences

See detailed instructions below for more information about these settings.

## Remotes & Accessories

Before pairing your bluetooth devices, make sure they're in pairing mode.



# Settings

## Device Preferences

### About

#### ● System update

We will provide software updates to continuously enhance your TV and correct any issues that may impact your user experience; therefore, we recommend that you keep your TV connected to the Internet to automatically receive updates when they are available.

#### ● Device name

Change a name for your TV, also you can choose "Don't change", The name will be shown to devices that are available for sharing data.

#### ● Restart

Restart your TV.

#### ● Status

View system message, including: IP address, MAC address, Bluetooth address, Serial Number, etc.

#### ● Legal information

Click to read the legal information.

#### ● Model / Version / Software version / Netflix ESN / Android security patch level / Kernel version / Build

View related menu information.

### Date & time

#### ● Automatic date & time:

Use network-provided time. You can also set the current time manually when Off is selected.

#### ● Set date

Set the date.

#### ● Set time

Set the time.

#### ● Set time zone

Select your time zone.

#### ● Use 24-hour format

Set the time to display in a 12 or 24-hour format.

### Timer

#### ● Power On Time Type

Set the type Off, On, Once.

#### ● Auto Power On Time

Set the clock for the time you want the TV to turn on automatically.

#### ● Power Off Time Type

Set the type Off, On, Once.

#### ● Auto Power Off Time

Set the clock for the time you want the TV to turn off automatically.

### Language

Adjust the default Language settings for the TV.

### Keyboard

Adjust the default settings for the keyboard.

### Inputs

You can see the state of devices that the TV connected: Connected Input, Standby Inputs and Not connected Input etc.

### Consumer Electronic Control (CEC)

#### ● HDMI control

Allow the TV to control HDMI devices.

#### ● Device auto power off

Power off HDMI devices with the TV.

#### ● TV auto power on

Power on the TV with HDMI device.

#### ● HDMI EDID Version

Select the EDID version.

#### ● CEC Device List

You will see the CEC device list If the TV access CEC device.

#### NOTE

-HDMI cables must be used to connect HDMI CEC-compatible devices to your TV.

-The HDMI CEC feature of the connected device must be turned on.

-If you connect an HDMI device that is not HDMI CEC-compatible, all the HDMI-CEC Control features do not work.

-Depending on the connected HDMI device, the HDMI-CEC Control feature may not work.

### Power

#### ● Sleep Timer

Set the sleep timer to automatically turn the TV off within a specified time: off, 10 Minutes, 20 Minutes, 30 Minutes, 40 Minutes, 50 Minutes, 60 Minutes, 90 Minutes and 120 Minutes.

#### ● Picture off

When you select this option, the screen will not display the picture. You can only listen the audio. Press any button except the [] button, volume [+ / -] buttons and mute button to restore operation.

#### ● Switch off Timer

Set the timer to automatically turn the TV off within a specified time: off, 30 Minutes, 60 Minutes, 90 Minutes, 120 Minutes, 150 Minutes, 180 Minutes, 210 Minutes and 240 Minutes.

#### ● No Signal Auto Power Off

You can set how long after no signal, the TV will automatically shut down.

# Settings

## Picture

### ● Picture Mode

If you'd like to configure the settings for your picture, then there are seven types of picture modes available: **User, Standard, Vivid, Sport, Movie, Game, and Energy Saving.**

### ● Auto BackLight

You can set to Off, Low, Middle or High.

### ● BackLight

Adjust backlight Level to change the overall brightness of the screen.

### ● Brightness

Adjust the Brightness level to generate lighter or darker images.

### ● Contrast

Adjust the Contrast level to increase or decrease how bright images appear.

### ● Saturation

Adjust the saturation of color settings.

### ● HUE

Adjust the hue of color settings.

### ● Sharpness

Adjust how sharp or soft edges of images appear.

### ● Gamma

Adjust the Gamma to alter how the TV will respond to the grayscale content.

### ● Color Temperature

Select a preset color temperature. Adjust how warm(red) or cool(blue) the white areas of an image appears.

### ● Display mode

Adjust the display mode.

### ● Advanced Video

Advanced settings for video.

### ● Color Tuner

Adjust the color tuner settings.

### ● 11 Point White Balance Correction

Adjust the intensity of red, green and blue lights to view the true colors of all images in the picture.

### ● Reset to Default

Reset current picture settings to factory mode.

## Sound

### ● System Sounds

Set system sounds on or off.

### ● Sound Style

Select a preset sound mode to suit the type of content you are listening to: **User, Standard, Vivid, Sports, Movie, Music, News.**

### ● Balance

Adjust the left and right speaker strength to optimize audio for a specific location.

### ● Equalizer Detail

Boost the volume at different frequencies.

### ● ARC

Set up TV Speakers or External Audio System.

### ● Digital Output

Select the digital audio output format that best suits the audio device type. Choose **PCM** if you have an amplifier that does not support Dolby Digital technology.

### ● SPDIF Delay

Adjust SPDIF Delay.

### ● Auto Volume Control

Turn on or off the Auto Volume Control.

### ● DTS-StudioSound

Enable DTS-StudioSound.

### ● Reset to Default

Reset current audio settings to factory mode.

## Storage

See the information of the Internal shared storage.

## Home screen

### ● Customize channels

Add or delete the app icon from Home screen.

### ● Enable video previews

Enables or disables the video previews.

### ● Enable audio previews

Enables or disables the audio previews.

### ● Reorder apps / Reorder games

Rearrange the Apps screen.

### ● Android TV Home / Android TV Core Services

See the information of open source software licences.

## Retail Mode

Turn on or off Retail Mode.

## Google Assistant

You can view permissions about accounts and limit the search results.

## Chromecast built-in

You can view Open source licenses and Version number.

## Screen saver

Enable and set Screen saver when the TV is idle.

# Settings

## Location

Your TV can use different modes to access location information. Each mode uses different sources to estimate the TV's location.

## Usage & Diagnostics

Help improve Android performance by automatically sending diagnostics information.

## Accessibility

### ● Audio Description

Choose to leave the Audio Description feature On or Off.

### ● Visually Impaired

You can set Visually Impaired On or Off. The function can be used to meet the needs of visually impaired people.

### ● Hearing Impaired

You can set Hearing Impaired On or Off. The function can be used to meet the needs of hearing impaired people.

### ● Captions

Displays and sets the TV closed captions.

### ● High contrast text

Improves contrast for visually impaired. The function can be used to meet the needs of visually impaired people.

## Reset

Reset your TV back to the factory default.

# Smart Functions

## Home

---

The simple design of the Home screen menu makes it easy to navigate. And you can easily add or delete applications in the Home interface according to your needs.

To access the Home screen, press the home button on your remote control and use the D-pad to make your selection.

### Indicators and Icons on the top of the Home screen

- **Google Assistant**  
You can search movies, TV, and more by speaking.
- **Google Search**  
You can search movies, TV, and more by typing.
- **Notifications**  
Notifications can come from the system, an external device, an application, the media player etc.
- **Inputs**  
Select the Input source depending on the device you have connected to your TV.
- **Connected/Disconnected**  
Show whether the network is connected.
- **Settings**  
Settings lets you configure the TV, set app options, add accounts, and change other preferences.
- **Time**  
You can always view the current time on the Home screen.

### Names of sections that appear on the Home screen

The Home screen displays the following section names:

- **Apps**  
This is the one location where you have access to all the apps on your TV. You can enjoy a wide range of services including video streaming.
- **Customize channels**  
Add and remove channels from your Home screen.

## Media

---

Playing Media contents

Press the [ **Media** ] button to enter media or press the home button on your remote control use the D-pad to click [ **MultiMediaPlayer** ].

Play multimedia contents stored on your USB devices, etc.

You must obtain any required permission from copyright owners to download or use copyrighted content. Toshiba cannot and does not grant such permission.

# Troubleshooting

## Self Diagnosis

If the TV does not operate as usual or appears to be faulty please read carefully this section. Many operational issues can be resolved by users.

It is also advisable to unplug the TV from the AC socket on the wall for 60 seconds or more, then reconnect and start again. This simple procedure helps in restoring stable conditions for electric circuits and firmware of the unit.

Please contact Manufacturer Customer Care if the problem is unresolved or you have other concerns.

| SYMPTOMS  | POSSIBLE SOLUTIONS  |
|---|---|
| No sound or picture.  | <ul style="list-style-type: none"> <li>Check if the power cord is plugged into a powered AC outlet.</li> <li>Check to see if the LED light is on or not. If it is, then the TV is receiving power.</li> </ul>   |
| I have connected an external source to my TV and I get no picture and/or sound.                       | <ul style="list-style-type: none"> <li>Check for the correct output connection on the external source and for the correct input connection on the TV.</li> <li>Make sure you have made the correct selection for the input mode for the incoming signal.</li> </ul> |
| When I turn on my television, there is a few second delay before the picture appears. Is this normal? | Yes, this is normal. That is the TV searching for previous setting information and initializing the TV.   |
| Picture is normal, but no sound.  | <ul style="list-style-type: none"> <li>Check the volume settings.</li> <li>Check if the TV is muted.</li> </ul>   |
| Sound but no picture or black and white picture.  | <ul style="list-style-type: none"> <li>If black and white picture first unplug TV from AC outlet and re-plug after 60 seconds.</li> <li>Check that the Color is set to 50 or higher.</li> <li>Try different TV channels.</li> </ul>                                 |
| Sound and picture distorted or appear wavy.   | <ul style="list-style-type: none"> <li>An electrical appliance may be affecting TV set. Turn off any appliances, if interference goes away, move appliance farther away from TV.</li> <li>Insert the power plug of the TV set into another power outlet.</li> </ul> |
| Sound and picture is blurry or cuts out momentarily.  | <ul style="list-style-type: none"> <li>If using an external antenna, check the direction, position and connection of the antenna.</li> <li>Adjust the direction of your antenna or reset or fine tune the channel.</li> </ul>                                       |
| Remote control does not work.   | <ul style="list-style-type: none"> <li>Confirm that TV still has power and is operational.</li> <li>Change the batteries in the remote control.</li> <li>Check if the batteries are correctly installed.</li> </ul>   |

| SYMPTOMS  | POSSIBLE SOLUTIONS   |
|---|--|
| Smart Television with wireless network capability Wi-Fi fail to join a local network. | <ul style="list-style-type: none"> <li>Configure the local wireless router or access point for WPA-PSK security before attempting to connect the TV to the Wi-Fi network.</li> <li>Follow instruction in the User Manual of the television to setup a wireless connection</li> </ul> |
| Horizontal/vertical stripe on picture or picture is shaking.                          | Check if there is interfering source nearby, such as appliance or electric tool.   |
| The plastic cabinet makes a "clicking" type of sound.                                 | "Click" sound can be caused when the temperature of the television changes. This change causes the television cabinet to expand or contract, which makes the sound. This is normal and the TV is OK.   |

## Other Information

### Specifications

Features, appearance and specifications are subject to change without notice.

| Item                               |                     | 32" (32V35KP/32E35KP)   |
|------------------------------------|---------------------|---|
| Dimension<br>(W × H × D)           | Without Stand       | 717 × 428 × 86 mm   |
|                                    | With Stand          | 717 × 473 × 186 mm  |
| Weight                             | Without Stand       | 3.8 kg  |
|                                    | With Stand          | 3.9 kg  |
| Active Screen Size (Diagonal)      |                     | 80 cm   |
| Screen resolution                  |                     | 1366 × 768  |
| Audio power                        |                     | 8 W + 8 W   |
| Power consumption                  |                     | 50 W  |
| Power supply                       |                     | 100-240V~ 50/60Hz   |
| Receiving systems                  | Analog              | PAL-D/K, B/G, I, SECAM-D/K, B/G   |
|                                    | Digital             | DVB-T/T2, DVB-C   |
| Wireless LAN Module specifications | Model               | WF-M38G-UTH1  |
|                                    | Frequency Range     | 2.4~2.4835GHz   |
|                                    | Output Power (Max.) | 2.4~2.4835GHz 17dBm   |
| Bluetooth Module specifications    | Model               | WF-M38G-UTH1  |
|                                    | Frequency Range     | 2.4~2.4835GHz   |
|                                    | Output Power (Max.) | 2.4~2.4835GHz, Class1, 6dBm   |
| Environmental conditions           |                     | Temperature: 5°C - 45°C<br>Humidity: 20% - 80% RH<br>Atmospheric pressure: 86 kPa - 106 kPa                                       |
| HDMI Input                         |                     | RGB / 60 Hz (800×600, 1024×768)<br>YUV / 60 Hz (480 I, 480 P, 720 P, 1080 I, 1080 P)<br>YUV / 50Hz (576 I, 720 P, 1080 I, 1080 P) |

| Item                               |                     | 43" (43V35KP/43E35KP)   |
|------------------------------------|---------------------|---|
| Dimension<br>(W × H × D)           | Without Stand       | 955 × 558 × 87 mm   |
|                                    | With Stand          | 955 × 606 × 200 mm  |
| Weight                             | Without Stand       | 6.4 kg  |
|                                    | With Stand          | 6.5 kg  |
| Active Screen Size (Diagonal)      |                     | 108 cm  |
| Screen resolution                  |                     | 1920 × 1080   |
| Audio power                        |                     | 10 W + 10 W   |
| Power consumption                  |                     | 75 W  |
| Power supply                       |                     | 100-240V~ 50/60Hz   |
| Receiving systems                  | Analog              | PAL-D/K, B/G, I, SECAM-D/K, B/G   |
|                                    | Digital             | DVB-T/T2, DVB-C   |
| Wireless LAN Module specifications | Model               | WF-M38G-UTH1  |
|                                    | Frequency Range     | 2.4~2.4835GHz   |
|                                    | Output Power (Max.) | 2.4~2.4835GHz 17dBm   |
| Bluetooth Module specifications    | Model               | WF-M38G-UTH1  |
|                                    | Frequency Range     | 2.4~2.4835GHz   |
|                                    | Output Power (Max.) | 2.4~2.4835GHz, Class1, 6dBm   |
| Environmental conditions           |                     | Temperature: 5°C - 45°C<br>Humidity: 20% - 80% RH<br>Atmospheric pressure: 86 kPa - 106 kPa                                       |
| HDMI Input                         |                     | RGB / 60 Hz (800×600, 1024×768)<br>YUV / 60 Hz (480 I, 480 P, 720 P, 1080 I, 1080 P)<br>YUV / 50Hz (576 I, 720 P, 1080 I, 1080 P) |

## Other Information

### Media Format List

#### Video:

| Number | Container | Video Codec (file type) | File Extension Name                               | Sampling rate SPEC | Bit Rate                         | Profile  | Remark           |
|--------|-----------|-------------------------|---|--------------------|----------------------------------|--|------------------|
| 1      | MPG       | Mpeg1                   | .dat .mpg.mpeg                                    | 1920x1080 @ 60fps  | 80Mbps                           | MP@HL  | Y                |
| 2      |           | Mpeg2                   | .dat .mpg.mpeg                                    | 1920x1080 @ 60fps  | 80Mbps                           | MP@HL  | Y                |
| 3      | MPEG      | Mpeg1                   | .dat .mpg.mpeg                                    | 1920x1080 @ 60fps  | 80Mbps                           | MP@HL  | Y                |
| 4      |           | Mpeg2                   | .dat .mpg.mpeg                                    | 1920x1080 @ 60fps  | 80Mbps                           | MP@HL  | Y                |
| 5      | MPEG2-PS  | MPEG2                   | .vob  | 1920x1080 @ 60fps  | 80Mbps                           | MP@HL  | Y                |
| 6      | MP4       | Mpeg4                   | .mp4  | 1920x1080 @ 60fps  | 40Mbps                           | Simple Profile and Advanced Simple Profile @Level 5.GMC is not supported                           | Y                |
| 7      |           | H.264                   | .mp4  | 1920x1080 @ 30fps  | 62.5Mbps                         | Main Profile and High Profile@Up to Level 4.1  | Y                |
| 8      |           | Motin JPEG              | .mp4  | 1920x1080 @ 30fps  | 10Mbps                           | N/A  | Y                |
| 9      | MKV       | Mpeg1,2,4               | .mkv  | 1920x1080 @ 60fps  | 80Mbps(Mpeg1,2)<br>40Mbps(Mpeg4) | MPEG1,2: MP@HL<br>MPEG4: Simple Profile and Advanced Simple Profile @Level 5 ;GMC is not supported | Y                |
| 10     |           | H.264                   | .mkv  | 1920x1080 @ 30fps  | 62.5Mbps                         | Main Profile and High Profile@Up to Level 4.1  | Y                |
| 11     |           | Motin JPEG              | .mkv  | 1920x1080 @ 30fps  | 10Mbps                           | N/A  | Y                |
| 12     | AVI       | Mpeg2,4                 | .divx.avi   | 1920x1080 @ 60fps  | 80Mbps(Mpeg2)<br>40Mbps(Mpeg4)   | MPEG2: MP@HL<br>MPEG4: Simple Profile and Advanced Simple Profile @Level 5 ;GMC is not supported   | Y:avi<br>N:.divx |
| 13     |           | H.264                   | .divx.avi   | 1920x1080 @ 30fps  | 62.5Mbps                         | Main Profile and High Profile@Up to Level 4.1  | Y:avi<br>N:.divx |
| 14     |           | Motin JPEG              | .divx.avi   | 1920x1080 @ 30fps  | 10Mbps                           | N/A  | Y:avi<br>N:.divx |
| 15     | ASF       | Mpeg2,4                 | .asf.wmv  | 1920x1080 @ 60fps  | 80Mbps(Mpeg2)<br>40Mbps(Mpeg4)   | MPEG2: MP@HL<br>MPEG4: Simple Profile and Advanced Simple Profile @Level 5 ;GMC is not supported   | Y:.asf<br>N:wmv  |
| 16     |           | H.264                   | .asf.wmv  | 1920x1080 @ 30fps  | 62.5Mbps                         | Main Profile and High Profile@Up to Level 4.1  | Y:.asf<br>N:wmv  |
| 17     | FLV       | H.264                   | .swf.flv  | 1920x1080 @ 30fps  | 62.5Mbps                         | Main Profile and High Profile@Up to Level 4.1  | Y:.flv<br>N:.swf |
| 18     |           | H.265                   | .mp4 .mov.3gpp .3gp.ts .trp .tp. mkv.webm.flv.avi | 1920x1080 @ 60fps  | 50Mbps                           | Main / Main 10Profile and High Tier @Level 4.1   | Y                |

## Other Information

### Audio:

| Number | Container | Audio Codec (file type) | File Extension Name  | Sampling rate SPEC     | Bit Rate  | Remark |
|--------|-----------|-------------------------|--|------------------------|---|--------|
| 1      |           | MPEG1 Layer2            | .MP3   | 16KHz ~ 48KHz          | 8Kbps ~ 384Kbps   | Y      |
| 2      |           | MPEG1 Layer3            | .MP3   | 16KHz ~ 48KHz          | 8Kbps ~ 320Kbps   | Y      |
| 3      |           | AAC, HEAAC              | .m4a.aac   | 8KHz ~ 48KHz           | AAC-LC:12KHz ~ 576KHz<br>HEAAC V1:6KHz ~ 288KHz<br>HEAAC V2:3KHz ~ 144KHz | Y      |
| 4      |           | WMA                     | .wma   | 8KHz ~ 48KHz           | 128bps ~ 320Kbps  | Y      |
| 5      |           | WMA Pro                 | .wma   | 8KHz ~ 96KHz           | <768kbps  | Y      |
| 6      |           | LPCM                    | N/A<br>(work with video files only)  | 8KHz ~ 48KHz           | 64Kbps ~ 1.5Mbps  | Y      |
| 7      |           | IMA-ADPCM/MS-ADPCM      | N/A<br>(work with video files only)  | 8KHz ~ 48KHz           | 32Kbps ~ 384Kbps  | Y      |
| 8      |           | AC-3                    | .ac3 .avi.mkv .mka.<br>webm .divx.3gpp .3gp.<br>mp4 .mov .m4a.ts .trp<br>.tp.dat .vob .mpg .mpeg.<br>wmv.asf.ogm | 32KHz 44.1KHz<br>48KHz | 32Kbps~ 640Kbps   | Y      |

### Photo:

| Number | Container | File Extension Name | Photo       | Resolution | Remark  |
|--------|-----------|---------------------|-------------|------------|---|
| 1      | JPEG      | .jpeg               | Base-line   | 15360x8640 | The limitation of max resolution depends on DRAM Size |
| 2      |           |                     | Progressive | 1024x768   | The limitation of max resolution depends on DRAM Size |
| 3      |           | .jpg                | Base-line   | 15360x8640 | The limitation of max resolution depends on DRAM Size |
| 4      |           |                     | Progressive | 1024x768   | The limitation of max resolution depends on DRAM Size |
| 5      | PNG       | .png                | N/A         | 9600x6400  | The limitation of max resolution depends on DRAM Size |
| 6      | BMP       | .bmp                | N/A         | 9600x6400  | The limitation of max resolution depends on DRAM Size |



# License Information

## License Information

- The terms HDMI and HDMI High-Definition Multimedia Interface, and the HDMI logo are trademarks or registered trademarks of HDMI Licensing Administrator, Inc. in the United States and other countries.



- DVB is a registered trademark of the DVB Project.

- [1] EIA/CEA-861-D compliance covers the transmission of uncompressed digital video with high-bandwidth digital content protection, which is being standardized for reception of high-definition video signals. Because this is an evolving technology, it is possible that some devices may not operate properly with the television.

### MP3 licence letter

MPEG Layer-3 audio coding technology licensed from Fraunhofer IIS and Thomson.

### MP4 licence letter

THIS PRODUCT IS LICENSED UNDER THE MPEG-4 VISUAL PATENT PORTFOLIO LICENSE FOR THE PERSONAL AND NON-COMMERCIAL USE OF A CONSUMER FOR (I) ENCODING VIDEO IN COMPLIANCE WITH THE MPEG-4 VISUAL STANDARD (MPEG-4 VIDEO) AND/OR (II) DECODING MPEG-4 VIDEO THAT WAS ENCODED BY A CONSUMER ENGAGED IN A PERSONAL AND NON-COMMERCIAL ACTIVITY AND/OR WAS OBTAINED FROM A VIDEO PROVIDER LICENSED BY MPEG LA TO PROVIDE MPEG-4 VIDEO. NO LICENSE IS GRANTED OR SHALL BE IMPLIED FOR ANY OTHER USE. ADDITIONAL INFORMATION INCLUDING THAT RELATING TO PROMOTIONAL, INTERNAL AND COMMERCIAL USES AND LICENSING MAY BE OBTAINED FROM MPEG LA, L.L.C. SEE [HTTP://WWW.MPEGLA.COM](http://www.mpeg-la.com)

### AVC licence letter

THIS PRODUCT IS LICENSED UNDER THE AVC PATENT PORTFOLIO LICENSE FOR THE PERSONAL AND NONCOMMERCIAL USE OF A CONSUMER TO (I) ENCODE VIDEO IN COMPLIANCE WITH THE AVC STANDARD ("AVC VIDEO") AND/OR (II) DECODE AVC VIDEO THAT WAS ENCODED BY A CONSUMER ENGAGED IN A PERSONAL AND NON-COMMERCIAL ACTIVITY AND/OR WAS OBTAINED FROM A VIDEO PROVIDER LICENSED TO PROVIDE AVC VIDEO. NO LICENSE IS GRANTED OR SHALL BE IMPLIED FOR ANY OTHER USE. ADDITIONAL INFORMATION MAY BE OBTAINED FROM MPEG LA, L.L.C. SEE [HTTP://WWW.MPEGLA.COM](http://www.mpeg-la.com)

### Licence Notification

#### TRADEMARK ACKNOWLEDGMENT

Manufactured under license from Dolby Laboratories. Dolby, Dolby Audio, Pro Logic, and the double-D symbol are trademarks of Dolby Laboratories. Confidential unpublished works. Copyright 1992-2019 Dolby Laboratories. All rights reserved.



#### Disposal of Used Electrical & Electronic Equipment

Packaging and electrical goods should be recycled appropriately, and not treated as household waste. Please dispose of this equipment at your applicable collection point for the recycling of electrical & electronic equipment waste. By ensuring the correct disposal of this product, you will help prevent potentially hazardous to the environment and to human health, which could otherwise be caused by unsuitable waste handling of this product. The recycling of materials will help conserve natural resources. Please do not therefore dispose of your old electrical and electronic equipment with your household waste. For more detailed information about recycling of this product, please contact your local city office, your household waste disposal service or the shop where you purchased the product.

