

Bar code

TOSHIBA

OWNER'S MANUAL

50M550KP

55M550KP

65M550KP

Owner's Record

You will find the model number and serial number on the back of the TV. Record these numbers in the spaces provided below. Refer to them whenever you call upon your Toshiba dealer regarding this product.

Model number:

Serial number:

Contents

Welcome to Toshiba

- Thank you for purchasing this Toshiba LED TV. This manual will help you use the exciting features of your new TV.
- Instructions in this manual are based on using the remote control.
- Please read all safety and operating instructions in this manual carefully, and keep this manual for future reference.
- LED TV is LCD Panel with LED Backlight.

Contents

Contents	1
Important Safety Precautions	2
Getting started	5
Accessories List	5
Installing the Stand or Wall Mount Bracket	5
TV Front	6
TV Rear	6
Terminals	7
Wired Setup	8
Wireless Setup	8
Connecting with an HDMI (ARC) Cable	8
Connecting with an HDMI Cable	8
Connecting with a USB Cable	8
Remote Control	9
Buttons on the Remote Control	9
Installing Batteries in the Remote Control	11
Pairing the Remote Control	11
Remote Control Operation Range	11
General Operation	12
Turn on/off your TV	12
Selecting the Input Source	12
Using the Live TV	12
EPG (GUIDE)	12
PVR/T.Shift	13
Menu	14
Using the Menu	14
Settings	17
Using the Settings	17
Device Preferences	18
Advanced System	19

Advanced Features	20
Getting Familiar with the Home Screen	20
Apps	20
Media	21
Troubleshooting	22
Picture Problem	22
Sound Problem	22
Picture and Sound Problem	22
Internet Problem	22
My File Won't Play	23
Recording/Timeshift Function Isn't Working	23
Other Issues	23
Other Information	24
Specifications	24
Media Format List	25
License Information	27

Disclaimer:

Images throughout this document are for illustrative purposes only and may differ from the actual product.

Designs and specifications are subject to change without notice.

Important Safety Precautions

Be sure to observe the following instructions and precautions to ensure safe use of this TV.

Installation

- WARNING: To prevent injury, this apparatus must be securely attached to a stable surface/wall in accordance with the installation instructions.**

Install the TV in a horizontal, stable location.

- If the TV is not installed securely, it may lean or fall over and cause an injury.
- To prevent injury, use the exclusive optional stand or wall-hanging bracket to install this TV on a stable surface or wall securely in accordance with a qualified technician.
- To secure the TV, use a sturdy strap from the hook(s) on the rear of the TV to a wall stud, pillar, or other immovable structure. Make sure the strap is tight, secure, and parallel to the floor.

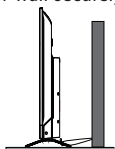

Only for the model with P-clip

- Never place the TV in an unstabilized location such as on a shaky table, incline or location subject to vibration.**

- Only use cabinets or stands recommended by the TV manufacturer.
- Only use furniture that can safely support the TV.
- Ensure that the TV is not hanging over the edge of the supporting furniture.
- Never place the TV on tall furniture (for example, cupboards or bookcases) without anchoring both the furniture and the TV to a suitable support.
- Never stand the TV on cloth or other material placed between the TV and supporting furniture.

The TV may drop or fall off, which may cause an injury or damage.

- Never stand or climb on the TV.**

- Educate children about the dangers of climbing on furniture to reach the TV or its controls.

Be especially careful in households with children to prevent them through climbing on top of the TV. It may move, fall over, break, become damaged or cause an injury.

- Always connect the power plug to an appropriate electrical outlet equipped with 100-240V AC, 50/60Hz.**

Never use the TV outside the specified voltage range. It may cause a fire or an electric shock.

About the fuse

In a three pin earthing-type, the fuse fitted in this plug is approved by ASTA or BSI to BS1362. It should only be replaced by a correctly rated and approved type and the fuse cover must be refitted.

About the use

- Make sure to insert the plugs firmly, when plugging the AC power cord into the TV set end and wall outlet end.
- Make sure to hold the plug, when unplugging the AC power cord.
- Never use other cord except for supplied AC power cord, and never use the supplied power cord for any other purpose.

- Never insert or remove the power plug with wet hands.**

This may cause an electric shock.

- Never block or cover the slots and openings in the cabinet.**

- Never place the TV so that it is facing upward or on its side.
- Never place the TV in a closet, bookcase or other similar area where the ventilation is poor.

- Never drape a newspaper, tablecloth or curtain on the TV.
- When installing the TV against a wall, always keep the TV at least 10cm away from the wall.
- Never place the TV on a soft unstable surface, such as a carpet, or a cushion.

The inside of this TV will overheat if the ventilation holes are covered, blocked or sealed, which may result in a fire.

- Never place the TV near a heater or in direct sunlight.**

The surface of the cabinet or power cord may melt and result in a fire or an electric shock.

- Never place the TV in an area exposed to high humidity levels, such as in a bathroom or close to a humidifier.**

This may cause a fire or an electric shock.

- Never place the TV next to a stove where it will be exposed to oil, smoke, or steam, or in a location where there is a large quantity of dust.**

This may cause a fire or an electric shock.

- Precautions for moving the TV.**

- When moving the TV, be sure to remove the plug from the wall outlet and disconnect the aerial cable and audio/video cables, any steady ties and mounting screw. A fire or an electric shock may result if the power cord is damaged.
- When carrying the TV, at least two people are needed. Be sure to carry it upright.
- Never carry the TV with the screen facing up or down.

- Precautions for installing on outdoor aerial.**

An outside aerial system should not be located in the vicinity of overhead power lines, or other electric light or power circuits.

If the aerial falls down or drops, it may cause an injury or an electric shock.

Use

- Never place hot objects or open flame sources, such as lighted candles or nightlights, on or close to the TV.**

High temperatures can melt plastic and lead to fires.

- The apparatus shall not be exposed to dripping or splashing and that no objects filled with liquids, such as vases, shall be placed on the apparatus.**

When liquids are spilled or small items are dropped inside the TV, this may cause a fire or an electric shock.

If small objects drop inside the TV, turn off the TV and remove the power plug from the outlet immediately and contact a service technician.

- Never insert objects (metal or paper) or pour water inside the TV through ventilation holes and other openings.**

These items may cause a fire or an electric shock. If these objects are inserted inside the TV, turn off the TV and remove the power plug from the outlet immediately and contact a service technician. Be especially careful that children do not insert objects in the TV.

- When the TV will not be used for a long period of time, such as during vacation or travel, remove the power plug from the wall outlet for safety.**

The TV is not completely disconnected from the power supply line, as minute current is consumed even when the Power switch is turned off.

The Mains plug or an appliance coupler is used as the disconnect device, therefore the disconnect device shall remain readily operable.

Important Safety Precautions

5. Never pull on the power cord when removing the plug from the wall outlet.

Always hold the plug firmly when removing it. If the power cord is yanked, the cord may become damaged and a fire or an electric shock may occur.

6. Never cut, break, modify, twist, bunch up or bent the cord or apply excessive force or tension to it.

Never place heavy objects on the cord or allow it to overheat as this may cause damage, a fire or an electric shock. Contact a service technician if the power cord is damaged.

7. If there is thunder or lightning, never touch the aerial cable or other connected cables.

You may suffer an electric shock.

8. Turn off the TV before unplugging the power cord.

Failure to do so, may cause a malfunction.

9. Listening to music at high volume levels and for extended durations can damage one's hearing.

In order to reduce the risk of damage to hearing, one should lower the volume to a safe, comfortable level, and reduce the amount of time listening at high levels.

10. In dry environment due to static electricity, the product may be restart and return to the main OSD interface, USB player interface or the previous source mode.

You can continue to use the TV when appear this phenomenon.

Service

1. Never repair, modify or disassemble the TV by yourself.

It may cause a fire or an electric shock.

Consult a service technician for inspection and repairs.

2. When a malfunction occurs, or if smoke or an unusual odor comes from the TV, turn off the TV and remove the power plug from the outlet immediately.

Make sure that the smoke or smell has stopped, then contact a service technician. If the TV is still used in this condition, it may cause a fire or an electric shock.

3. If the TV is dropped or the cabinet is broken, turn off the TV and remove the power plug from the outlet immediately.

If the TV has power in this condition, it may cause a fire or an electric shock. If the cabinet is broken, be careful when handling the TV to prevent an injury.

Contact a service technician for inspection and repair.

4. When the TV reaches the end of its useful life, ask a qualified service technician to properly dispose of the TV.

Cleaning

CAUTION: Avoid using chemicals (such as air refreshers, cleaning agents, etc.) on or near the TV pedestal. Studies indicate that plastics may weaken and crack over time from the combination effects of chemical agents and mechanical stress (such as weight of TV). Failure to follow these instructions could result in serious injury and/or permanent damage to TV and TV pedestal.

1. Remove the power plug before cleaning.

Never use solvents such as benzene or thinner to clean the TV.

- These solvents may distort the cabinet or damage its finish.
- If rubber or vinyl products remain in contact with the TV for a long time, a stain may result.

If the cabinet becomes dirty, clean it with a soft, dry cloth.

When cleaning the surface of the LED display, wipe the panel surface gently with a soft, dry cloth.

2. Periodically disconnect the power plug from the outlet and check it.

If dust has collected on the power plug connectors, clean off the dust with a dry cloth.

This dust may cause a fire due to reduced insulation on the plug.

Important information

1. About LCD screen

- If you have the LCD screen facing to the sun, the LCD screen will be damaged. Be aware of locating the TV close to a window or outdoors.
- Never press the LCD screen strongly or scratch it, and never put anything on it. These actions will damage the LCD screen.

2. About cabinet and LCD screen

Never spray volatile compounds such as insecticide on the cabinet and LCD screen. This may cause a discoloration or damage the cabinet and LCD screen.

3. About afterimage

If a still picture is displayed, an afterimage may remain on the screen, however it will disappear. This is not a sign of malfunction.

4. Some pixels of the screen do not light up

The LCD display panel is manufactured using an extremely high level of precision technology, however sometimes some pixels of the screen may be missing picture elements or have luminous spots. This is not sign of malfunction.

5. About Interference

The LCD display may cause interference in image, sound, etc. of other electronic equipment that receives electromagnetic waves (e.g. AM radios and video equipment).

6. About using under the low temperature places

If you use the TV in the room of 0°C or less, the picture brightness may vary until the LCD monitor warms up. This is not a sign of malfunction.

7. When disposing of or transferring ownership of the TV

Before disposing of or transferring ownership of the TV, perform "Resetting the TV".

Important Safety Precautions

Recording using an USB storage device

- Be sure to select the correct country/region for use.
Use of the recording function may not be possible depending on the selected country/region.
Use with incorrect settings may violate certain laws or other regulations, and may result in criminal punishment.
In such cases, TOSHIBA CORPORATION and the Toshiba Group shall bear no responsibility whatsoever.
- The recording function has been designed for private use and entertainment in your home environment.
Please note that any commercial use of the recording function could lead to copyright infringement of authors' rights. Toshiba asks you to respect the intellectual property rights of third parties.
- Before recording to a device connected to the TV, make a test recording and check the recording performance.
- Toshiba shall not be liable for compensation or incidental damages of any kind whatsoever resulting from content that was not properly recorded on the recording device or that was modified or lost.
- Toshiba shall not be liable for damages of any kind whatsoever (breakdown of the recording device, modification or loss of the recorded content, etc.) resulting from malfunction, operating failure or incorrect operation due to combining with another connected device.
- Do not turn off the power supply to the USB storage device or disconnect the connecting cable while the USB storage device is operating. Doing so may result in loss of the recorded data or malfunction of the USB storage device.
- The recording function is not available in all countries/regions.
- Please note that recording on the USB storage device is no longer playable after the TV's main-board is exchanged during service.
- If the time information is incorrect, programed recording may not be performed properly.
Furthermore, if the time information differs according to the currently viewed channel, programed recording may not be performed properly depending on tuning operations.

Exemptions

- Toshiba is not liable for any damage caused by fires, natural disaster (such as thunder, earthquake, etc.), acts by third parties, accidents, owner's misuse, or uses in other improper conditions.
- Toshiba is not liable for incidental damaged (such as profit loss or interruption in business, modification or erasure of record data, etc.) caused by use or inability to use of product.
- Toshiba is not liable for any damage caused by neglect of the instructions described in the owner's manual.
- Toshiba is not liable for any damage caused by misuse or malfunction through simultaneous use of this product and the connected equipment.

When using a wireless network

CAUTION:

- Bluetooth™ and Wireless LAN devices operate within the same radio frequency range and may interfere with one another. If you use Bluetooth™ and Wireless LAN devices simultaneously, you may occasionally experience a less than optimal network performance or even lose your network connection.
- If you should experience any such problem, immediately turn off either your Bluetooth™ or Wireless LAN device.

- Actual performance can vary, including lower wireless network capacity, data throughput rate, range and coverage.
- Performance depends on many factors, conditions and variables, including distance from the access point, volume of network traffic, building materials and construction, operating system used, mix of wireless products used, interference and other adverse conditions.

Wireless LAN and your Health

Wireless LAN products, like other radio devices, emit radio frequency electromagnetic energy. The level of energy emitted by Wireless LAN devices, however, is far less than the electromagnetic energy emitted by wireless devices such as mobile phones.

Because Wireless LAN products operate within the guidelines found in radio frequency safety standards and recommendations, TOSHIBA believes Wireless LAN is safe for use by consumers. These standards and recommendation reflect the consensus of the scientific community and result from deliberations of panels and committees of scientists who continually review and interpret the extensive research literature.

In some situation or environments, the use of Wireless LAN may be restricted by the proprietor of the building or responsible representatives of the organization. Such restrictions may apply in environments where the risk of interference to other devices or services is perceived or identified as harmful.

If you are uncertain of the policy that applies to the use of wireless devices in a specific organization or environment, you are encouraged to ask for authorization to use the Wireless LAN device prior to turning on the equipment.



AC voltage: This symbol indicates that the rated voltage marked with the symbol is AC voltage.



This equipment is a Class II or double insulated electrical appliance. It has been designed in such a way that it does not require a safety connection to electrical earth.

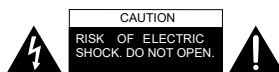

- This lightning flash with arrowhead symbol within an equilateral triangle is intended to alert the user to the presence of non-insulated "dangerous voltage" within the product's enclosure that may be of sufficient magnitude to constitute a risk of electric shock.
- Warning: To reduce the risk of electric shock, do not remove cover (or back) as there are no user serviceable parts inside. Refer servicing to qualified personnel.
- The exclamation point within an equilateral triangle is intended to alert the user to the presence of important operating and maintenance instructions in the literature accompanying the appliance.

Getting started

Accessories List

The following accessories are included with TV:

OWNER'S MANUAL × 1 Remote Control × 1 AAA Battery × 2
 Base Stand × 2 Screw × 4
 Power Cord × 1

NOTE

- The accessories may be different from the list above due to different models, countries/regions, please refer to the actual accessory bag.

Installing the Stand or Wall Mount Bracket

CAUTION

- Be sure to disconnect the AC power cord before installing a stand or wall mount brackets.
- The display on your TV is fragile. Make sure the TV screen is not scratched or damaged by hard objects or from pressure.
- After the installation is complete, make sure the TV is steady on a table or firmly attached to a wall mount, before removing all protective film, if any.

Installing the Stand

- Carefully place your TV face-down on a soft, flat surface to prevent damage to the TV or scratching to the screen.
- Take out the Base Stand from the accessory bag and then insert the stand into the bottom slots of the TV.
- Secure the Base Stand to the TV with 4 screws in accessory tightly.

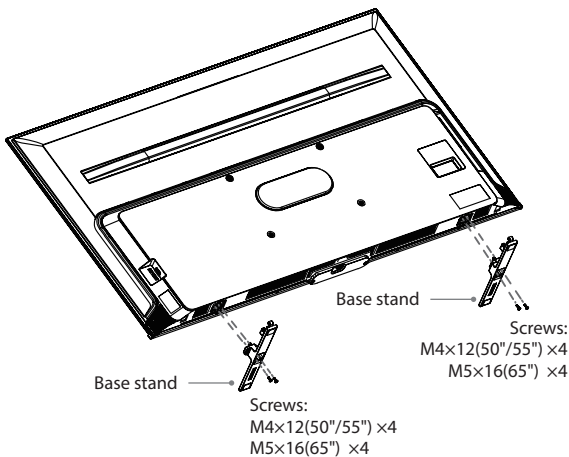

Installing the Wall Mount Bracket

Before mounting the TV, remove the TV stand if you have already attached it, and make sure the wall mount bracket supports the weight of your TV.

CAUTION

When mounting the TV on a wall, follow instructions provided with the wall mount bracket. If it is not correctly mounted, the TV may fall and cause property damage or personal injury.

- Place spacers between the TV and bracket.
- Make sure the tilt angle between the TV screen and the vertical surface is no more than 15 degrees.

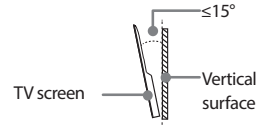

- Standard dimensions are shown below.

Wall mount hole pattern (mm)	300 × 200 (50"/55") 400 × 200 (65")
Wall mount screw size	M6

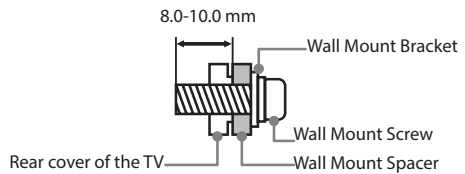

NOTES

- The diameter and length of the screws differ depending on the wall mount bracket model.
- Wall mount bracket is optional. Your TV may not have wall mount bracket. Please refer to the actual accessories.

Installing the P-Clip

Please place the TV on a horizontally stable surface, and then use P-Clip to connect the TV and the wall or pillar.

- Fix the larger side of P-Clip to the screw hole on the back of TV set with a M6×12 screw.
- Fix the other side of P-Clip to the wall or pillar with a ST4×25 screw.

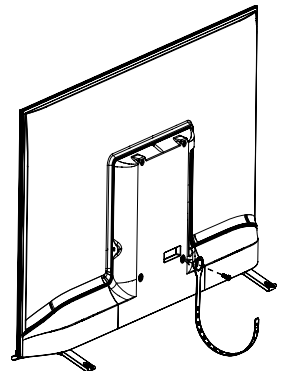

NOTES

- Insecure installation may cause the tilt or falling of the product, and further lead to personal injuries or product damages.
- P-clip and corresponding screws may not included with TV set, please purchase them by yourself if necessary.

Getting started

TV Front

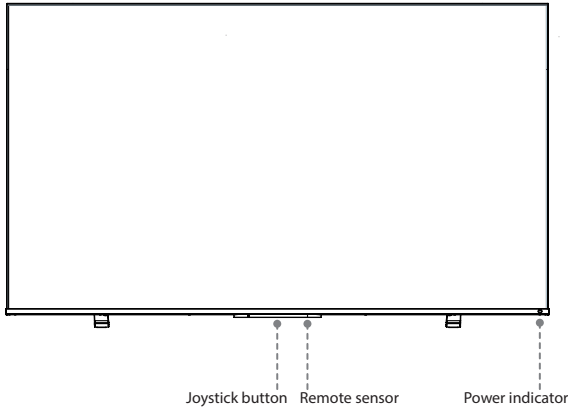

Item	Description
Remote sensor	Receive remote signals from the remote control. Do not put anything near the sensor, as its function may be affected.
Power indicator	The light is red in standby mode, the light is off when TV is on.
 Standby / Source	Select among the different input signal sources or put the TV in standby mode, or you can turn on the TV when the TV in standby mode.
 VOL + / -	Toggle the joystick button left and right to adjust the volume.
 CH + / -	Toggle the joystick button forward and backward to control the channel.

TV Rear

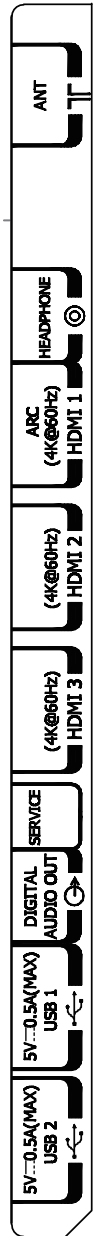
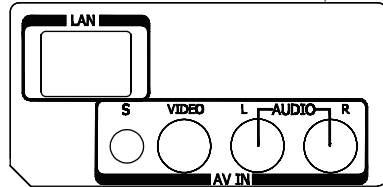
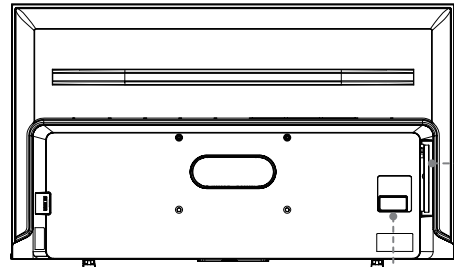











NOTES

- Check the jacks for position and type before making any connections. Loose connections can result in image or color problems. Make sure that all connections are tight and secure.
- Not all A/V devices have the ability to connect to a TV, please refer to the user's manual of your A/V device for compatibility and connections procedure.
- Before connecting external equipment, remove the mains plug from the wall socket. Otherwise, it may cause electric shock.
- Service jack is not available for you to connect an external device. It can only be used by our factory for testing purposes.

Getting started

Terminals

ANT		Connect an outdoor VHF/UHF antenna.
HDMI		Connect an HDMI cable from an external A/V equipment.
HDMI (ARC)		Connect an HDMI cable from an external digital audio system.
VIDEO INPUT	VIDEO 	Connect a composite video cable and left-right audio cables from an external AV device. The VIDEO can be used to connect a range of equipment, including video recorders, camcorders, decoders, satellite receivers, DVD players, or games consoles.
	L 	
	R 	
USB		Connect a USB device for browsing photos, music and movies.
DIGITAL AUDIO OUT		Connect an optical cable from an external digital audio system.
LAN		Connect an Ethernet cable to access a network or the Internet.
HEADPHONE		Connect headphones to listen to the sound coming from the TV. Note: Excessive sound pressure from earphones can cause hearing loss.
SERVICE		This port is not available for you to connect an external device. It can only be used by our factory for testing purposes.

NOTE

- The location and names of the terminals on the TV may vary according to TV model, and not all terminals are available on all models.

Getting started

Wired Setup

Connect your TV to your network by connecting the LAN port on the back of your TV to an external modem or router using a LAN (Ethernet/Cat 5) cable.

See the illustration below.

NOTES

- You get access to the Internet through your TV.
- You are recommended to use a modem or router that supports Dynamic Host Configuration Protocol (DHCP). Modems and routers that support DHCP automatically provide the IP address, subnet mask, gateway, and DNS, so you don't have to enter them manually. Most home networks already have DHCP.

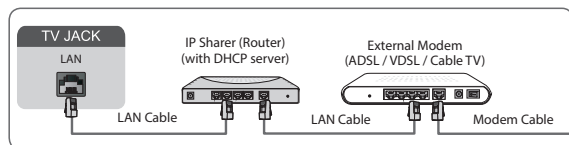

Wireless Setup

To connect your TV to your wireless network, you need a wireless router or modem. See the illustration below.

The TV's built-in Wireless LAN Adapter supports the IEEE802.11 ac/a/b/g/n communication protocols.

NOTES

- You get access to the Internet through your TV.
- Connect to an available wireless network.
- Make sure that you have the wireless router's SSID and password before attempting to connect.

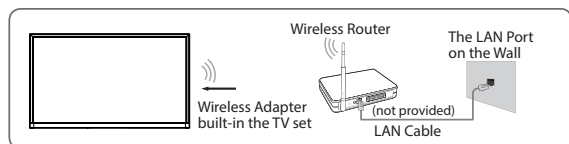

Connecting with an HDMI (ARC) Cable

Connect an HDMI cable from an external digital audio system. ARC enables the TV to directly output the digital sound through an HDMI cable. Please note that it works only when the TV is connected to the audio receiver that supports the ARC (Audio Return Channel) function.

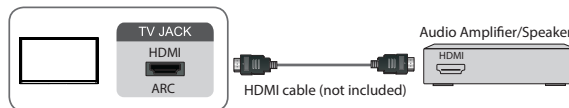

NOTES

- When this port is used as the ARC function, it can be used as signal input when DVD is connected to amplifier and the amplifier is connected to the TV at the same time. (Some amplifiers may not support series connection.)
- ARC work by auto as per input ARC condition.

Connecting with an HDMI Cable

Connect an HDMI cable from an external A/V equipment. Some devices such as DVD player require HDMI signal to be set to output in the device's settings. Please consult your device user manual for instructions. Please note that the HDMI connector provides both video and audio signals, so it's not necessary to connect an audio cable.

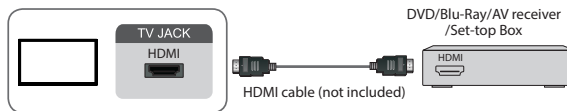

Connecting with a USB Cable

Connect the USB devices such as hard drives, USB sticks and digital cameras for browsing photos, listening to music.

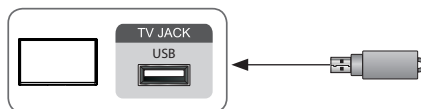

- Support the U disk 4G, 8G, 16G, 32G, 64G, 128G and other common market size, and 8T hard drive is currently supported.
- Support format: NTFS, FAT32, EXT4.

Using the USB storage device function

The USB storage device function can be used to record and view digital broadcast programmes.

Read the precautions below before recording or viewing programmes using the USB storage device function.

NOTES

- Be sure to select the correct country/region for use.
Use of the recording function may not be possible depending on the selected country/region.
Use with incorrect settings may violate certain laws or other regulations, and may result in criminal punishment.
In such cases, TOSHIBA CORPORATION and the Toshiba Group shall bear no responsibility whatsoever.
- Recorded programmes saved on the USB storage device can only be viewed on this TV. They cannot be viewed when connected to another TV (including the same model of TV), a PC, or other device.
- You cannot watch one channel while recording another.
- If the recording time to the USB storage device is too short, no data may be saved.
- You cannot record video input signals on the USB device.
- Not all types of broadcast may be recordable.
- After programming the TV to record digital broadcasting, do not disconnect the power plug before recording starts.
- Should video or audio recording fail due to malfunction of the TV or poor reception, no compensation shall be paid.
- Certain digital cameras may not be compatible with the TV.

Remote Control

Buttons on the Remote Control



- ① POWER: Turn the TV on or into standby mode
- ② : Select input source
- ③ 0-9: Direct channel selection or numbers input
- ④ TEXT: Turn on/off the teletext function
- ⑤ TV: Enter the Live TV in the Home screen (TV mode)
- ⑥ Special function buttons
- ⑦ : Display the current programme information
- ⑧ : Display the quick setup menu
- ⑨ OK / Confirmation button
- ⑩ D-pad: Allow you to navigate the OSD menus and adjust the system settings to your preference
- ⑪ Back: Return to previous menu
- ⑫ GUIDE: Display the Electronic Programme Guide (DTV mode)
- ⑬ Google Assistant of TV
- ⑭ + / -: Adjust the volume
- ⑮ P / : Switch channel
- ⑯ : Display the Home screen
- ⑰ PVR: Record the current program (DTV mode)
- ⑱ SUBTITLE: Press to display the Subtitle Language menu
- ⑲ : Mute or restore the TV sound
- ⑳ S.MODE: Select the sound mode
- ㉑ P.MODE: Select the picture mode
- ㉒ : Media content control function buttons
- ㉓ APPS: Fast access to applications
- ㉔ MEDIA: Enter the media
- ㉕ : Fast access to all applications

NOTE

The included remote control will vary depending on model, country/region. Check information according to the actual remote control in the accessory bag.

Remote Control

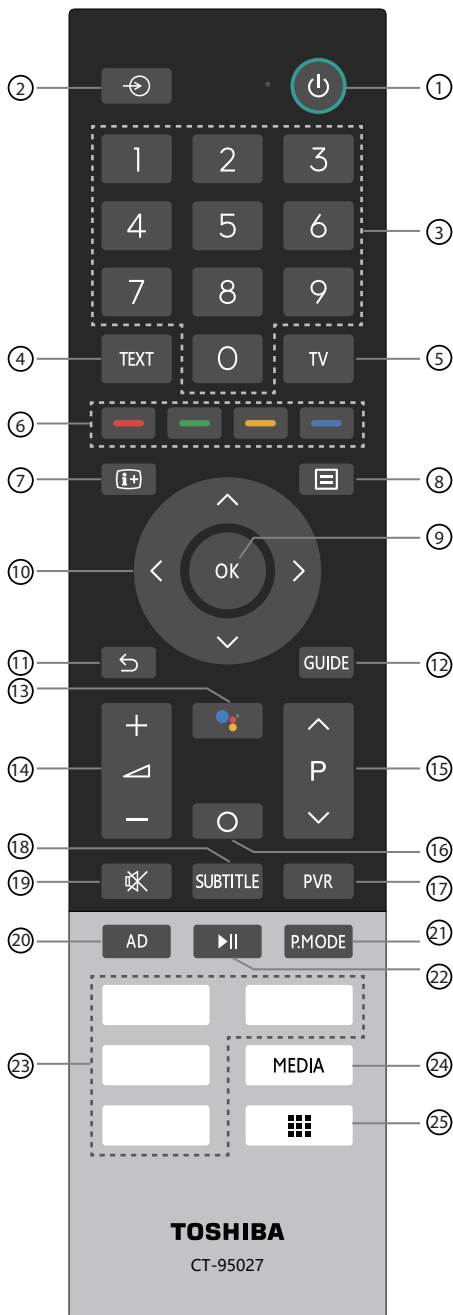

- ① POWER: Turn the TV on or into standby mode
- ② : Select input source
- ③ 0-9: Direct channel selection or numbers input
- ④ TEXT: Turn on/off the teletext function
- ⑤ TV: Enter the Live TV in the Home screen (TV mode)
- ⑥ Special function buttons
- ⑦ : Display the current programme information
- ⑧ : Display the quick setup menu
- ⑨ OK / Confirmation button
- ⑩ D-pad: Allow you to navigate the OSD menus and adjust the system settings to your preference
- ⑪ Back: Return to previous menu
- ⑫ GUIDE: Display the Electronic Programme Guide (DTV mode)
- ⑬ Google Assistant of TV
- ⑭ + / -: Adjust the volume
- ⑮ P ▲ / ▼: Switch channel
- ⑯ : Display the Home screen
- ⑰ PVR: Record the current program (DTV mode)
- ⑱ SUBTITLE: Press to display the Subtitle Language menu
- ⑲ : Mute or restore the TV sound
- ⑳ AD: Set the Audio Description on or off
- ㉑ P.MODE: Select the picture mode
- ㉒ : Media content control function buttons
- ㉓ APPS: Fast access to applications
- ㉔ MEDIA: Enter the media
- ㉕ : Fast access to all applications

NOTE

The included remote control will vary depending on model, country/region. Check information according to the actual remote control in the accessory bag.

Remote Control

Installing Batteries in the Remote Control

Press the release button on the back of the remote control to remove the battery compartment cover.

1. Slide the back cover to open the battery compartment of the remote control.
2. Insert two AAA size batteries. Make sure to match the (+) and (-) ends of the batteries with the (+) and (-) ends indicated in the battery compartment.
3. Close the battery compartment cover.

❶ Gently push and slide

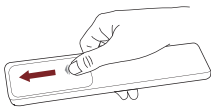

❷ Insert the batteries

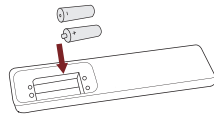

❸ Gently push and slide

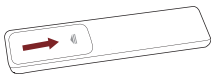

NOTES

- Product image is only for reference, actual product may vary in appearance.

Handling the Batteries

- Incorrect use of batteries may cause corrosion or battery leakage, which could cause fire, personal injury or damage to property.
- Only use the battery type indicated in this manual.
- Do not mix old and new batteries or different types of batteries.
- Do not dispose of used batteries as domestic waste. Dispose of them in accordance with local regulations.
- Battery chemicals can cause a rash. If the batteries leak, clean the battery compartment with a cloth. If chemicals touch your skin, wash immediately.
- If you do not intend to use the remote control for a long time, remove the batteries.
- Remove depleted batteries immediately to prevent battery acid from leaking into the battery compartment.

Pairing the Remote Control

1. Pair the remote to the TV after you power it on. Make sure your remote is close to this TV around 3 meters. Press and hold the [] / [MENU] button at least 3 seconds to start pairing.
2. If the remote pairs successfully, a confirmation will display on the screen. If it does not pair successfully, an unsuccessful message will display. Repeat step 1.

NOTES

- This function is only available on certain models and bluetooth remote control in some countries/regions.
- If an unknown error occurred with the remote then it could have been caused by interference. Try to remove what's causing the interference

and pair it again.

- If an unknown error occurred in the remote control while the battery power is normal, you can take out the batteries and press any key for 1~2 seconds, then the remote control can work normally.
- The remote cannot be paired to the TV while the TV is in standby mode.

Remote Control Operation Range

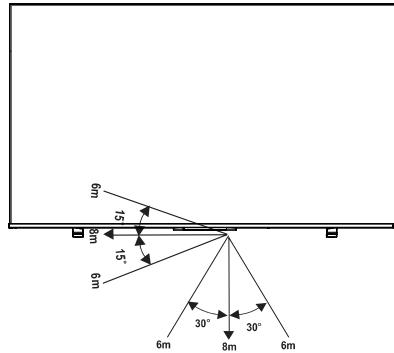

General Operation

Turn on/off your TV

Turn on your TV for the first time

- Connect the mains cable to the mains socket after you have completed all the connections.
- The first time you turn the TV on, it will go straight into the Installation Guide.
- The guide setting is completed according to the boot navigation prompt. The navigation information is specific to the actual condition.
- The Home screen will be your starting point for navigating the TV.

To turn your TV on or off :

- 1 Plug the AC power cord into a socket outlet of AC power supply.
- 2 When the TV is powered on, press the [] button on the remote control, to turn TV on or off.

NOTES

- When your TV is in standby mode, it is still consuming power. To completely disconnect power, please remove the mains plug from the mains socket.
- If your TV does not receive an input signal for several minutes, it automatically goes into standby mode.

Selecting the Input Source

Select the Input Source depending on the video device you have connected to your TV.

To select the input source:

1. Turn on your TV, then press the [] button on the remote, and the list of Source appears.
2. Press the [**Up / Down**] buttons to select the input source.
3. Press the [**OK**] button to confirm your selection.

Using the Live TV



To view broadcast programs, press the [] button on your remote to select **Channels**.

Channel search guide

When you select **Channels** as input, if no TV channels were saved before, you will be prompted to do a channel search. You can also go to **Menu** > **Channels** to change the channel settings.

Launch Live TV

After channel scanning is done for the first time, the screen will display LiveTV operating tutorial, including: how to Load info Bar, how to load the channel list and so on.

- [**Up**] Load info bar
- [**OK**] Load channel list
- [**GUIDE**] Load EPG (GUIDE)
- [**MENU** / ] Load onscreen menu
- [**Down**] Initiate PVR or Timeshift
- [ / ] Jump to previous channel

Viewing channel information

As you use the [**P** / **P**] button on your remote to scroll through channels, an information banner appears on the top of the screen.

Viewing a channel list

After you have done an automatic channel scan (if you're using an antenna) or receiving your channels through a cable provider, you can view your list of channels by pressing [**OK**] button on your remote. You will see the channel list display on the screen.

Creating and editing Favorites List

To quickly access your most-watched channels, you can create a Favorites List.

To create and edit your Favorites List:

There are 2 ways to enter the edit menu :

1. Press the [**OK**] button and the [**Left**] button on your remote when viewing channels to select **Channel List** > **Favorite List** > **Add fav list** (Max 4 fav lists can be added)
2. Press the [] / [**MENU**] button on your remote to access the **Menu**, and then select **Channels** > **Channel Edit** > **Favorite 1** > **Add channels**.

Viewing your Favorite list

To view channels that you've added to your Favorites List simply press [**OK**] button on your remote to call out the channel list.

The channel list appears on the screen and heart-shaped icons are shown next to the channels that make up your Favorites List.

EPG (GUIDE)

It provides convenience to check TV programmes that will be available in the next 7 days. The information displayed by the EPG is made available by the commercial television networks for digital channels only. The EPG also provides a simple way to program the recording of your favorite programmes and a reminder function which can switch channel automatically at scheduled time so that you do not miss programmes of interest. (The availability and amount of programme information will vary, depending on the particular broadcaster).

In Live TV, press the [**GUIDE**] button on the remote control to display channel information on program guide list.

● Watch

In Guide (EPG), when a current programme is selected, press the [**OK**] button to watch.

● PVR/Reminder/Detail

In Guide (EPG), press the [**Up / Down**] buttons to select the channels, press the [**Left / Right**] buttons to select program based on the time schedule.

Press the [**OK**] button to select PVR or Reminder.

Press the [**Up / Down / Left / Right**] buttons to change and set different options.

General Operation

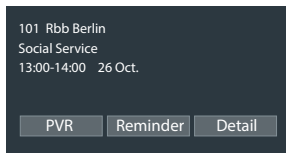

- Select and set Start time/End Time: Press the [**OK**] button, and then press the [**0-9**] button to input the desired numbers. (Selecting and setting end time is only available for PVR)
- Repeat: You can select from Once, Daily, Mon to Fri, Sat to Sun, Sun, Mon, Tue, Wed, Thu, Fri and Sat.

NOTES

- Reminder is only available for programmes that haven't been aired yet.
- A storage device must be attached to the television for recording purposes.
- The TV will record the program even in standby mode.
- The PVR function is only available on certain models in some country/region.

● Page Up/Down

In Guide (EPG), press the [**P**^ / **P**∨] buttons to move programme listing page up/down.

● Schedule

In Guide (EPG), press the **RED** button view a list of scheduled reminders and recordings.

● Detail

In Guide (EPG), press the **GREEN** button to display detailed information of the selected programme (only available on certain models in some country/region).

● 24h-

In Guide (EPG), press the **YELLOW** button to go backwards a day.

● 24h+

In Guide (EPG), press the **BLUE** button to move forwards a day.

PVR/T.Shift

PVR

The PVR function allows you to easily record digital television content for later viewing. The function is only available in DTV source. To use PVR, you must connect a USB device for recording. The format of the storage disk should be FAT32. The PVR will not function if a data storage device has not been connected.

● Schedule Recording

In Live TV, press [**GUIDE**] button, select the programme to be played, press [**OK**] button to set the appointment time and period, the reservation is successful. Press the **RED** button to view the schedule recording. In the schedule recording list, you can readjust the reservation information that has been set.

● Instant Recording

Press [**Down**] button to select PVR.

Select the partition, and the USB device speed will be tested (appear when using for the first time).

You can choose to Manual stop or automatically match the programme time.

● Standby record

If you press the power button during recording, TV will go into standby mode but the recording process is still going on. If you press power button again and wake up the TV, recording process will not be affected. After recording, the recorded file will be automatically saved to the disk.

● Recording List

Viewing the recorded programmes.

Press the [**Down**] button on your remote to select **Recording List** > **Recorded**, You can watch or delete recorded programmes.

NOTES

- Available on Channel (DTV) source only.
- The storage space of your USB device should be no less than 2G (for 15 minutes high definition video).
- If the transfer rate of your hard disk is too slow, a pop-up notice will appear, in this case, you can try another one.
- The PVR function doesn't support analogue channels.
- The schedule recording function is not available while you are watching a programme that is currently being broadcast.
- Some broadcasters may restrict to record the programme.
- During the recording progress, channels locked with Channel Lock (password needed) are disabled to watch.
- The PVR function is disabled for scrambled channels (CI module needed).
- The PVR function is only applicable in certain models.

T.Shift

This option allows you to pause and rewind live TV. This function operates by recording temporarily to a storage device. Please ensure your storage device is connected and there is enough free disk space. Otherwise the recording will not commence.

Press the [**Down**] button on the remote to select T.Shift and then the menu will appear, click the [**II**] icon to pause the live broadcast and click the [**▶**] icon to play. Click the [**◀◀**] icon to rewind and click the [**▶▶**] icon to fast forward. Click the [**■**] icon to exit the function and watch the current broadcast.

NOTES

- The T.Shift function doesn't support analogue channels.
- The storage space of the USB device should be no less than 1G.
- The T.Shift function is disabled for channels locked with Channel Lock or scrambled channels (CI module or password needed).
- The Timeshift function is only applicable in certain models in some country/region..

Menu

Using the Menu

- 1 Press the [] / [MENU] button on your remote to enter the Menu in TV mode.

The **Menu** consists of the following settings:

- **Picture**
- **Sound**
- **Channels**
- **Parental Control**
- **Teletext**
- **Subtitle**
- **EPG (GUIDE)**
- **HDMI 2.0 Format (only for HDMI mode)**
- **Audio Language (MTS)**
- **Audio Only**
- **Sleep Timer**
- **Settings**
- **Help**

- 2 In each menu, you can:

- Press the [**Up / Down / Left / Right**] buttons to select an item,
- Press the [**OK**] button to enter the sub-menu or to set on or off,
- Press the [**Left / Right**] buttons to adjust the value,
- Press the [**←**] / [**↶**] button to return to the previous menu.

NOTE

The menus in the user manual may vary slightly from the actual screen.

Picture

● **Backlight**

Adjust Dynamic Backlight Control and Backlight Level to change the overall brightness of the screen.

- **Dynamic Backlight Control:** Enhance the contrast ratio between light and dark areas of the picture. You can select **On** or **Off**.

 **NOTE:** Some models don't support this function.

- **Backlight level:** Adjust how bright you want images to appear, lower settings create darker images. The Backlight level is only available when Dynamic Backlight Control select Off.

● **Picture Mode**

Select a preset picture mode to best suit the content you're viewing.

Once you choose the mode, you can adjust the picture based on the following settings:

● **Contrast**

Adjust the Contrast level to increase or decrease how bright images appear.

● **Brightness**

Adjust the Brightness level to generate lighter or darker images.

● **Colour**

Adjust the colour intensity of the picture for a more vibrant image.

● **Tint**

Adjust the colours from a green to magenta tint to view the natural skin tones of people on the screen.

● **Sharpness**

Adjust how sharp or soft edges of images appear.

● **Aspect Ratio**

Adjust the Aspect Ratio to stretch or zoom in on your picture.

NOTES

- Using the special functions to change the size of the displayed image (e.g. changing the height/width ratio) for the purpose of public display or commercial gain may infringe on copyright laws.
- If the aspect ratio of the selected format is different from the one of the TV transmission or video programme, it can cause a difference in vision.
- When using PC connected via HDMI terminal, the moving image quality may be deteriorated.

● **Advanced Settings**

Adjust advanced picture settings based on your viewing preference.

- **Overscan:** Change the video size settings to slightly crop the edges of the displayed image.
- **Colour Temperature:** Select a preset colour temperature adjust to **Low**, **Mid-Low**, **Medium** or **High** the white areas of an image appear.
- **Motion Enhancement:** Reduce seeing afterimages that are left on the screen when viewing fast-moving objects.

 **NOTE:** Some models don't support this function.

- **Noise Reduction:** Improve how clear the picture appears by reducing noise.

- **Digital Noise Reduction:** Reduce MPEG block noise and provides clearer edge transitions.

 **NOTE:** Some models don't support this function.

- **HDMI Dynamic Range:** Adjust the HDMI signal range to be more suitable for the content. (HDMI mode only)

- **Active Contrast:** Automatically darken dark areas and lighten light areas of images to see more details.

- **Colour Space:** Change the range of colours the TV displays.

 **NOTE:** Some models don't support this function.

● **Calibration Settings**

Adjust the colour space and Gamma to best suit the content you're viewing.

- **Colour Tuner:** Adjust the Hue, Saturation, Brightness of colour settings and restore colour tuner settings.

- **White Balance:** Adjust the intensity of red, green and blue lights to view the true colours of all images in the picture and make reset.

- **Gamma:** Adjust the Gamma to alter how the TV will respond to the grayscale content. In a dark room choose a Higher number like 2.2. In a brighter area select a Lower number like 2.0. In general, 2.2 is normally recommended.

 **NOTE:** Some models don't support this function.

Menu

- **Gamma Calibration:** Adjust selected Gamma curve.
- **RGB Only:** View images based on default settings or choose off, red, green or blue.

● Apply Picture Settings

Adjust current picture mode to apply to current source or all sources.

● Reset

Reset current picture settings to factory mode.

Sound

● System sounds

Open the default system sound.

● Sound Mode

Select a preset sound mode to suit the type of content you are listening to.

● Speakers

Select the speakers which you want to use.

● Dolby Atmos

Turn the Dolby Atmos on or off.

 **NOTE:** Dolby Atmos may not be supported depending on the model.

● TruBass HDX

Optimize overall sound quality by increasing bass, making dialog clear and natural, and widening the sound field.

● TruSurround: X

Provide surround sound experience with psycho-acoustic processing to place sounds beside, behind, and above the viewer. For best results use with Surround Sound.

● Dialog Clarity

Improve dialogue clarity.

● TruVolume HD

Maintain consistent loudness levels from wide dynamic range programs, loud commercials, and channel or input changes.

 **NOTE:** TruBass HDX, TruSurround: X, Dialog Clarity and TruVolume HD may not be supported depending on the model.

● Wall Mount Setup

Automatically optimize the sound based on the position of the TV.

● Advanced Settings

Tune the audio settings and quality of the TV.

- **Balance:** Adjust the left and right speaker strength to optimize audio for a specific location.
- **Auto Volume Control:** Turn Auto Volume Control on or off.
- **Digital Audio Out:** Select the digital audio output format that best suits the audio device type.
 **NOTE:** When connected the TV with optical, Dolby Digital Plus is not suggested.
- **Digital Audio Delay:** Adjust the digital audio output delay time to sync sound from an external speaker with the images on the TV.

- **Lip Sync:** Synchronize the displayed image with the audio output.

- **Equalizer:** Boost the volume at different frequencies.

- **Headphone Mode:** Change the way audio is sent through the type of device that's connected to your TV Audio Out port.

 **NOTE:** Some models don't support this function.

- **Headphone Volume:** Independently adjust the volume of audio out devices.

 **NOTE:** Some models don't support this function.

● Audio Type

- **Audio Type:** Select the audio type of programmes.

- **Voiceover output:** Select the voiceover audio out.

 **NOTE:** Some models don't support this function.

- **Voiceover volume:** Independently adjust the volume of voiceover.

● Reset

Reset current audio settings to factory mode.

Channels

● Tuner Mode

Select if you receive TV channels over the air (antenna) or through a cable set top box as the input will be used during a channel scan.

● Auto Scan

Automatically scan for channels to view programmes from your TV source.

● Channel Edit

Manually edit the channel list order to your preference.

● Postal Code

Set the Postal Code.

 **NOTE**

- This function may not be available in your country/region.

● Advanced Settings

Adjust advanced settings for Channel.

- **DTV Manual Scan:** Search and store the channels under DTV mode.

- **ATV Manual Scan:** Search and store the channels under ATV mode.

- **ATV Fine Tuning:** Fine tuning current channel to improve the programme picture.

- **Channel List Auto-Update:** Allow your TV auto-update the channel list from the content provider.

- **Language:** Select a desired language from the list in DTV mode.

 **NOTE:** This function may not be available in your country/region.

- **PVR&Time-Shift Settings:** Initialize the external USB disk to support PVR and Time-Shift. (Since the function record temporary the program onto a hard disk only)

Menu

Parental Control

The Parental Control setting allows you to block content that is not appropriate for children to watch.

Turning Parental Control On

- 1 Go to Locks.
- 2 Press the [**OK**] button on your remote, a Create PIN window displays. Using the D-pad on your remote, create the password.
- 3 Press the [**OK**] button to turn the locks **On**.

You will see the other Parental Control settings change from a greyed out state to highlighted. When this occurs, begin adding other settings to the Block Time, Channel Block, Program Block, Input Block, Change PIN or Reset features.

● **Block Time**

Block certain channels and programmes during certain periods of time.

● **Channel Block**

Block selected channels.

● **Program Block**

Block programs by ratings.

● **Input Block**

Block selected inputs.

● **Change PIN**

Change the PIN that you use to access Parental Control.

NOTE

If you forget your password, call the Consumer Electronics Care Center.

● **Reset**

Reset Parental Control back to the factory setting.

Teletext

Display the teletext mode.

Subtitle

Select desired subtitles from the list if the selected channel supports multi-language subtitles. (Only available for DTV channels)

EPG (GUIDE)

Enter guide function under DTV mode.

It provides an overview of each digital channel's programme lineup.

HDMI 2.0 Format



Match the connected device output format. Select Enhanced for devices with output of 4K, 60Hz, 4:4:4, 4:2:2 or 4:2:0, 10 bit and above. (Only available for HDMI mode)

Audio Language (MTS)

You can choose the audio language in DTV mode and you can set MTS for Mono, Stereo, DUAL1 or DUAL2 in ATV mode.

 **NOTE:** This function may not be available in your country/region.

Audio Only

When you select this option, the screen will not display the picture. You can only listen to the audio. Press any button except the [] button, [ + / -] buttons and [] button to restore operation.

Sleep Timer

Set the sleep timer to automatically turn the TV off within a specified time: off, 10 Minutes, 20 Minutes, 30 Minutes, 40 Minutes, 50 Minutes, 60 Minutes, 90 Minutes and 120 Minutes.

Settings

Settings lets you configure the TV, set app options, add accounts, and change other preferences.

Help

● **System Message**

View system message, including: Serial Number, Service Code, Software Version, etc.

NOTE



Serial Number may not be displayed in your country/region.

● **Signal Diagnosis**

Perform self diagnosis to test Video Format, Audio Format, Colour Depth, etc.

Settings

Using the Settings

Press the [] button on your remote to enter the Home screen, and use the D-pad to select the  icon to access the Settings.

Picture / Sound / Parental Control

See other chapters for more information about these settings. For example, for Picture settings, see [Picture on page 15](#).

Network & Internet

● Wi-Fi

Turn on the Wi-Fi to access the Internet via a wireless network connection.

Select an available network, press [**OK**] to confirm. A screen will appear prompting you to enter the password if necessary.

● See all / See fewer

View all available network or fewer.

● Add new network

You can add wireless network.

● Scanning always available

Check to scan for networks even when Wi-Fi is turned off.

● Wake on Wireless Network

Using a wireless connection, turn on your TV with a screen-cast feature inside an app.

● Wake on LAN:

Using an Ethernet connection, turn on your TV with a screen-cast feature inside an app.

● Wake on Cast:

Using a cast connection, turn on your TV with a screen-cast feature inside an app.

● Connected / Not connected

Show whether the Ethernet is connected.

● Proxy settings

You can set the proxy server.

NOTE

HTTP proxy is used by the browser but may not be used by other apps.

● IP settings

Configure the IP setting for your network connection.

● Content Sharing

Allow to view videos, images and music shared from another device in your network.

Accounts & Sign In

You can use multiple Google Accounts on your TV. You may also be able to add other kinds of accounts, depending on your apps.

Apps

You can view details about an app or other item listed. The information and controls available vary among different types of apps.

Device Preferences

See [Device Preferences on page 19](#).

Remotes & Accessories

● Add accessory

Connect your Bluetooth devices (like a keyboard, a mouse, a soundbar etc.) to the TV.

Before you can use a Bluetooth device with your TV, you must first pair it.

1. Make the device you want to pair discoverable. See the documentation that came with your device to learn how to make it discoverable.

2. The TV displays the ID of all available devices in range

3. Click the ID of the Bluetooth device in the list on your TV to pair with it.

4. Follow the prompts to complete the pairing.

● Device List

Show up available devices.

Advanced System

See [Advanced System on page 20](#).

Settings

Device Preferences

Date & time

● Automatic date & time

Use network-provided time or use DTV-provided time (only available for DTV channels). You can also set the current time manually when Off is selected.

● Set date

Set the date.

● Set time

Set the time.

● Set time zone

Select your time zone.

● Jalaali

Turn the Jalaali On or Off.

NOTE

This function may not be available in your country/region.

● Daylight Savings

Select whether to apply Daylight Savings time to the TV.

NOTE

Some models don't support this function.

● Use 24-hour format

Set the time to display in a 12 or 24-hour format.

Language

Adjust the default Language settings for the TV.

Keyboard

Adjust the default settings for the keyboard.

Inputs

You can see the state of devices that the TV connected: Connected Input and Standby Inputs.

Consumer Electronic Control (CEC)

● HDMI control

Allow the TV to control HDMI devices.

● Device auto power off

Power off HDMI devices with the TV.

● TV auto power on

Power on the TV with HDMI device.

NOTE

- HDMI cables must be used to connect HDMI CEC-compatible devices to your TV.
- The HDMI CEC feature of the connected device must be turned on.
- If you connect an HDMI device that is not HDMI CEC-compatible, all the HDMI-CEC Control features do not work.

- Depending on the connected HDMI device, the HDMI-CEC Control feature may not work.

Storage

You can view the TV storage.

Home screen

● Customise channels

Add or delete the app channel row from Home screen.

● Enable video previews

Enable or disable the video previews.

● Enable audio previews

Enable or disable the audio previews.

● Reorder apps / Reorder games

Rearrange the Apps screen.

● Android TV Home / Android TV Core Services

See the information of open source software licences.

Google Assistant

View permissions about accounts and limit the search results.

Chromecast Android Shell (Chromecast built-in)

Enable you to extend your app to direct its streaming video and audio to the TV.

Screen saver

Enable Screen saver when the TV is idle.

Location

Your TV can use different modes to access location information. Each mode uses different sources to estimate the TV's location.

Usage & Diagnostics

Help improve Android performance by automatically sending diagnostics information.

Security & restrictions

Enable unknown sources, checking of apps installed for harmful behavior.

Reset

You can reset to the factory data.

About

You can view the version information, the status of network, and other information. You can also update the software version or change the TV's name.

● System update

We will provide software updates to continuously enhance your TV and correct any issues that may impact your user experience; therefore, you are recommended to keep your TV connected to the Internet to automatically receive updates when they are available.

Settings

- **Device name**

Choose a name for your TV. The name will be shown to devices that are available for sharing data.

- **Signal Diagnosis**

Perform self diagnosis to test Video Format, Audio Format, Colour Depth, etc.

Advanced System

Timer

- **Power On Timer Type**

Set the type Off, Daily, Once.

- **Power On Timer**

Set the clock for the time you want the TV to turn on automatically.

- **Power Off Timer Type**

Set the type Off, Daily, Once.

- **Power Off Timer**

Set the clock for the time you want the TV to turn off automatically.

Power

- **Sleep Timer**

Set the sleep timer to automatically turn the TV off within a specified time: off, 10 Minutes, 20 Minutes, 30 Minutes, 40 Minutes, 50 Minutes, 60 Minutes, 90 Minutes and 120 Minutes.

- **Power On Mode**

TV will be powered on based on the mode when TV is reconnected with AC power.

- **Auto Sleep**

Set the amount of time that you'd like for TV auto power off without any activity: Off, 3H, 4H.

 **NOTE**

This function may not be available in your country/region.

Store Mode

Home Mode uses less energy. Select Store Mode if the TV will be on display in a retail setting. Store Mode effects E-Streamer and other demo functions.

Support

- **Setup assistant (Setup Wizard)**

Use the Setup assistant for instructions to help you set up your TV.

- **Send Diagnostics and Usage**

Allow to send the diagnostics and usage of the report.

Help

- **System Message**

View system message, including: Serial Number, Service Code, Software Version, etc.

 **NOTE**

Serial Number may not be displayed in your country/region.

Advanced Features

Getting Familiar with the Home screen

The simple design of the Home screen menu makes it easy to navigate. And you can easily add or delete applications in the Home interface according to your needs.

To access the Home screen, press the [] button on your remote control and use the D-pad to make your selection.

Indicators and Icons on the top of the Home screen

● Google Assistant

You can search movies, TV, and more by speaking.

● Google Search

You can search movies, TV, and more by typing.

● Notifications

Notifications can come from the system, an external device, an application, the media player etc.

● Inputs

Select the Input source depending on the device you have connected to your TV.

● Network & Internet

You can set up the Network & Internet.

● Settings

Settings lets you configure the TV, set app options, add accounts, and change other preferences.

● Time

You can always view the current time on the Home screen.

Names of sections that appear on the Home screen

The Home screen displays the following section names.

● Apps

This is the one location where you have access to all the apps on your TV. You can enjoy a wide range of services including video streaming.

● Play Next

You can select types of content for play next, you can also manually add a programmes to play next by long-pressing on a programmes in the Home screen.

● Recommended content

Here the premium content will display on the screen, you can quickly enter these contents what you want.

Apps

Numerous factory-installed apps are available for you to choose from for your entertainment preferences.

Installing an App

To install an app:

- 1 From the Home screen, click on the **Apps** and select the **Get more apps**.
- 2 Use the navigation buttons on your remote to select the app that you want to install.
- 3 Select the **INSTALL**.

Removing an App

You can only delete apps that you've installed to the TV. Factory-installed apps can not be deleted.

To delete an app:

- 1 From the Apps screen, use the navigation buttons on your remote to select the app that you want to remove. Long press the [**OK**] button on your remote.
- 2 Click on **Uninstall**.
- 3 A dialog message displays that asks do you want to uninstall this app. Confirm and the icon is removed from the Apps screen.

NOTE

If an app is deleted, the information related to that app is also removed.

Moving App Icons around

To move an app:

- 1 From the Apps screen, use the navigation buttons on your remote to select the app that you want to move. Long press the [**OK**] button on your remote.
- 2 Click on **Move**.
- 3 Use the navigation buttons on your remote to move the location of app. Press the [**OK**] button to confirm.

Advanced Features

Media

Media is a central location for you to view or listen to different types of content (for example, your photos, music and movies) through the following methods:

- A USB thumb drive or hard drive.
- Compatible mobile phone, tablet or other personal devices: You can stream movies, music and photos that are stored on Compatible personal device and play or view the content on your TV.



Browsing Content

You have two ways to enter **Media**:

- Insert a USB device, a prompt message appears and you can choose whether to go to the **Media**.
- When your USB device is connected to the TV that doesn't show Media page, press the [] button on your remote, and browse down to click **Media**.

To browse through content based on the type that you wish to access:

- 1 Navigate to the appropriate menu tab on the screen and select **All Media, Videos, Photos, Music**.
- 2 Click on the name of the folder that contains your content.
- 3 Make your selection to play or view the content.

If you want to close out of the Media center, then press the []/[] button on your remote.

You must obtain any required permission from copyright owners to download or use copyrighted content. TOSHIBA cannot and does not grant such permission.

Troubleshooting

If the TV does not operate as usual or appears to be faulty, please read carefully this section. Many operational issues can be resolved by users.

It is also advisable to unplug the TV from the AC socket on the wall for 60 seconds or more, then reconnect and start again. This simple procedure helps in restoring stable conditions for electric circuits and firmware of the unit.

Picture Problem

When the TV has trouble with the picture, these steps may help resolve the problem.

The Problem	Possible Solutions
No picture, or black and white picture.	<ul style="list-style-type: none"> Unplug TV from AC outlet and re-plug after 60 seconds. Try different TV channels.
The picture is distorted.	<ul style="list-style-type: none"> The compression of video content may cause picture distortions, especially in fast moving pictures from sports programmes and action movies. If the signal reception is weak or poor, screen distortion may be visible but it is not a malfunction. Mobile phones used close to the TV (within 1m) may cause noise on analogue and digital channels.

Sound Problem

When the TV has difficulties with sound, these steps may help resolve the problem.

The Problem	Possible Solutions
There is no sound or the sound is too low at maximum volume.	<ul style="list-style-type: none"> Check the volume control of the device (cable or satellite box, DVD, Blu-ray, etc.) connected to your TV.
Picture is normal, but no sound.	<ul style="list-style-type: none"> Check the volume settings. Check if 'Mute' mode is set to on.
The speakers are making an odd sound.	<ul style="list-style-type: none"> Make sure that the audio cable is connected to the correct audio output connector on the external device. For antenna or cable connections, check the signal information. A low signal level may cause sound distortions.

Picture and Sound Problem

When the TV has difficulties with sound and picture, these steps may help resolve the problem.

The Problem	Possible Solutions
No sound and picture.	<ul style="list-style-type: none"> Check if the power cord is plugged into a powered AC outlet. Press the  button in the remote control to activate the unit from Standby. Check to see if the LED light is on or not. If it is, then the TV is receiving power.
I have connected an external source to my TV but I get no picture and/or sound.	<ul style="list-style-type: none"> Check the correct connection on the external source and the input connection on the TV. Make sure you have made the correct selection for the input mode for the incoming signal.
Sound and picture distorted or appear wavy.	<ul style="list-style-type: none"> Some electrical appliances may affect TV set. If you turn off the appliance and the interference goes away, then move it further away from TV. Insert the power plug of the TV set into another power outlet.
Sound and picture is blurry or cuts out momentarily.	<ul style="list-style-type: none"> If you use an external antenna, check the direction, position and connection of the antenna. Adjust the direction of your antenna or reset or fine tune the channel.

Internet Problem

When the TV has difficulties connecting to the Internet, these steps may help resolve the problem.

The Problem	Possible Solutions
The TV cannot connect to your network or apps.	<ul style="list-style-type: none"> Contact your Internet service provider. Make sure the TV has a network connection.
The wireless network connection failed.	<ul style="list-style-type: none"> Make sure your wireless modem/router is on and connected to the Internet.
The wireless network signal is too weak.	<ul style="list-style-type: none"> Position your wireless router, modem router, or access point in a central location. Avoid putting it in a corner.

Troubleshooting

My File Won't Play

When files aren't playing, this may help resolve the problem.

The Problem	Possible Solutions
Some files can't be played.	<ul style="list-style-type: none">This problem may occur with high-bitrate files. Most files can be played back, but you might experience problems with high-bitrate files.

Recording/Timeshift Function Isn't Working

When Timeshift or Schedule recording aren't working, these steps may help resolve the problem.

The Problem	Possible Solutions
Schedule Recording cannot be used.	<ul style="list-style-type: none">Check if there is a USB device connected to the TV.Recording will automatically stop if the signal becomes too weak.Check the free space on the USB device. The function will not work if there isn't enough storage space on the USB device.

NOTE

- The Recording/Timeshift functions are only applicable in certain models.

Other Issues

Use these procedures to resolve other issues that may occur.

The Problem	Possible Solutions
The TV is hot.	<ul style="list-style-type: none">Watching TV for an extended period of time causes the panel to generate heat. The heat from the panel is dissipated through internal vents running along the top of the TV. However, after extended use, you may feel hot when touch it. This heat, however, is not a defect and does not affect the TV's functionality.
The TV smells of plastic.	<ul style="list-style-type: none">This smell is normal and will dissipate over time.
The plastic cabinet makes a "clicking" type of sound.	<ul style="list-style-type: none">The 'click' sound can be caused when the temperature of the television changes. This change causes the television cabinet to expand or contract, which makes the sound. This is normal and the TV is OK.
Remote control does not work.	<ul style="list-style-type: none">Confirm that TV still has power and is operational.Change the batteries in the remote control.Check if the batteries are correctly installed.

Other Information

Specifications

Features, appearance and specifications are subject to change without notice.

Item		50"	55"
Dimension (W × H × D)	Without Stand	1115 × 649 × 81 mm	1228 × 713 × 81 mm
	With Stand	1115 × 670 × 259 mm	1228 × 733 × 259 mm
Weight	Without Stand	11.2 kg	14.0 kg
	With Stand	11.5 kg	14.4 kg
Active Screen Size (Diagonal)		50 inches (126 cm)	55 inches (139 cm)
Screen resolution		3840 × 2160	3840 × 2160
Speaker power		12W + 12W + 25W	12W + 12W + 25W
Power consumption		130W	150W
Item		65"	
Dimension (W × H × D)	Without Stand	1447 × 836 × 81 mm	
	With Stand	1447 × 856 × 320 mm	
Weight	Without Stand	18.5 kg	
	With Stand	19.1 kg	
Active Screen Size (Diagonal)		65 inches (164 cm)	
Screen resolution		3840 × 2160	
Speaker power		12W + 12W + 25W	
Power consumption		200W	
Power supply		100-240V~ 50/60Hz	
Receiving systems	Analog	PAL-D/K, B/G, I, SECAM-D/K, B/G	
	Digital	DVB-T/T2, DVB-C	
Wireless LAN Module specifications	Model	ZDGF7668AU-T	
	Frequency Range	2.4-2.4835GHz 5.15-5.85GHz	
	Output Power (Max.)	2.4-2.4835GHz 17dBm 5.15-5.25GHz 14dBm 5.25-5.35GHz(DFS Band) 14dBm 5.49-5.71GHz(DFS/TPC Band) 14dBm 5.725-5.85GHz(for Non EU) 14dBm	
Bluetooth Module specifications	Model	ZDGF7668AU-T	
	Frequency Range	2.4-2.4835GHz	
	Output Power (Max.)	2.4-2.4835GHz, Class1, 6dBm	
Environmental conditions		Temperature: 5°C - 45°C Humidity: 20% - 80% RH Atmospheric pressure: 86 kPa - 106 kPa	
HDMI Input		RGB / 60 Hz (640×480, 800×600, 1024×768) YUV / 60 Hz (480 I, 480 P, 720 P, 1080 I, 1080 P) YUV / 50 Hz (576 I, 576 P, 720 P, 1080 I, 1080 P) 24 Hz 25Hz 30 Hz 50 Hz 60 Hz (3840×2160)	

Other Information

Media Format List

Video:

Number	Container	Video Codec (file type)	File Extension Name	Sampling rate SPEC	Bit Rate	Profile	Remark
1	MPG	Mpeg1	.dat .mpg.mpeg	1080P @ 60fps	80Mbps		Y(.mpg.mpeg) N(.dat)
2		Mpeg2	.dat .mpg.mpeg	1080P @ 60fps	80Mbps	Main Profile	Y(.mpg.mpeg) N(.dat)
3	MPEG	Mpeg1	.dat .mpg.mpeg	1080P @ 60fps	80Mbps		Y(.mpg.mpeg) N(.dat)
4		Mpeg2	.dat .mpg.mpeg	1080P @ 60fps	80Mbps	Main Profile	Y(.mpg.mpeg) N(.dat)
5	MP4	Mpeg4	.mp4	1080P @ 60fps	40Mbps	Simple Profile and Advanced Simple Profile @Level 5	Y
6		H.264	.mp4	3840X2160 @ 60fps	135Mbps	Main Profile and High 10@Level 5	Y
7		H.265	.mp4	3840X2160 @ 60fps	100Mbps	Main/Main10 Profile, High Tier @Level 5.1	Y
8		Motion JPEG	.mp4	1080P @ 30fps	10Mbps		Y
9	MKV	Mpeg1,2,4	.mkv	1080P @ 60fps	40Mbps	MPEG2: MP@HL MPEG4: Simple Profile and Advanced Simple Profile @Level 5	Y
10		H.264	.mkv	3840X2160 @ 60fps	135Mbps	Main Profile and High 10@Level 5	Y
11		H.265	.mkv	3840X2160 @ 60fps	100Mbps	Main/Main10 Profile, High Tier @Level 5.1	Y
12		Motion JPEG	.mkv	1080P @ 30fps	10Mbps		Y
13		VP9	.mkv	3840X2160 @ 60fps	100Mbps	Profile0/2	Y
14	AVI	Mpeg2,4	.divx.avi	1080P @ 60fps	40Mbps	MPEG2: MP@HL MPEG4: Simple Profile and Advanced Simple Profile @Level 5	Y(.avi) N(.divx)
15		H.264	.divx.avi	3840X2160 @ 60fps	135Mbps	Main Profile and High 10@Level 5	Y(.avi) N(.divx)
16		Motion JPEG	.divx.avi	1080P @ 30fps	10Mbps		Y(.avi) N(.divx)
17	ASF	Mpeg2,4	.asf.wmv	1080P @ 60fps	40Mbps	MPEG2: MP@HL MPEG4: Simple Profile and Advanced Simple Profile @Level 5	Y(.wmv) N(.asf)
18		H.264	.asf.wmv	3840X2160 @ 60fps	135Mbps	Main Profile and High Profile@Level 4.0	Y(.wmv) N(.asf)
19	FLV	H.264	.swf.flv	3840X2160 @ 60fps	135Mbps	Main Profile and High Profile@Level 4.2	Y(.flv) N(.swf)
20	MPEG transport stream	H.265	.ts, .trp, .tp	3840X2160 @ 60fps	100Mbps	Main/Main10 Profile, High Tier @Level 5.1	Y
		H.264	.ts, .trp, .tp	3840X2160 @ 60fps	135Mbps	Main Profile and High Profile@Level 4.2	Y
		MPEG1/2	.ts, .trp, .tp	1080P @ 60fps	80Mbps	MP@HL	Y
21	WebM	VP9	.webm	3840X2160 @ 60fps	100Mbps	Profile0/2	Y

Other Information

Audio:

Number	Audio Codec(file type)	File Extension Name	Bit Rate	Sampling rate
1	MPEG1/2 Layer1	.MP3	32kbps ~ 448kbps	16kHz ~ 48kHz
2	MPEG1/2 Layer2	.MP3	8kbps ~ 384kbps	16kHz ~ 48kHz
3	MPEG1/2 Layer3	.MP3	8kbps ~ 320kbps	16kHz ~ 48kHz
4	AAC, HEAAC	.m4a.aac	24kbps ~ 384kbps	8kHz ~ 48kHz
5	WMA	.wma	128bps ~ 320kbps	8kHz ~ 48kHz
6	WMA Pro	.wma	<768kbps	~ 96kHz
7	LPCM	N/A (work with video files only)	64kbps ~ 1.5Mbps	8kHz ~ 48kHz
8	IMA-ADPCM/MS-ADPCM	N/A (work with video files only)	384kbps	8kHz ~ 48kHz
9	AC-3	.ts .mkv	32Kbps ~ 640Kbps	32KHz, 44.1KHz,48KHz

Photo:

Number	Container	File Extension Name	Photo	Resolution	Required DRAM size (Mbytes)	bytes
1	JPEG	.jpeg	Base-line	15360x8640 (1920X8 1080X8)	3.96	414720
2			Progressive	1024x768	6.00	6291456
3		.jpg	Base-line	15360x8640 (1920X8 1080X8)	3.96	414720
4			Progressive	1024x768	6.00	6291456
5	PNG	.png	non-interlace	9600x6400	3.66	3840000
6			interlace	1200x800	3.66	3840000
7	BMP	.bmp		9600x6400	3.66	3840000

License Information

License Information

- The terms HDMI and HDMI High-Definition Multimedia Interface, and the HDMI logo are trademarks or registered trademarks of HDMI Licensing Administrator, Inc. in the United States and other countries.



- DVB is a registered trademark of the DVB Project.
- [1] EIA/CEA-861-D compliance covers the transmission of uncompressed digital video with high-bandwidth digital content protection, which is being standardized for reception of high-definition video signals. Because this is an evolving technology, it is possible that some devices may not operate properly with the television.

MP3 licence letter

MPEG Layer-3 audio coding technology licensed from Fraunhofer IIS and Thomson.

MP4 licence letter

THIS PRODUCT IS LICENSED UNDER THE MPEG-4 VISUAL PATENT PORTFOLIO LICENSE FOR THE PERSONAL AND NON-COMMERCIAL USE OF A CONSUMER FOR (I) ENCODING VIDEO IN COMPLIANCE WITH THE MPEG-4 VISUAL STANDARD (MPEG-4 VIDEO) AND/OR (II) DECODING MPEG-4 VIDEO THAT WAS ENCODED BY A CONSUMER ENGAGED IN A PERSONAL AND NON-COMMERCIAL ACTIVITY AND/OR WAS OBTAINED FROM A VIDEO PROVIDER LICENSED BY MPEG LA TO PROVIDE MPEG-4 VIDEO. NO LICENSE IS GRANTED OR SHALL BE IMPLIED FOR ANY OTHER USE. ADDITIONAL INFORMATION INCLUDING THAT RELATING TO PROMOTIONAL, INTERNAL AND COMMERCIAL USES AND LICENSING MAY BE OBTAINED FROM MPEG LA, L.L.C. SEE [HTTP://WWW.MPEGLA.COM](http://www.mpegla.com)

AVC licence letter

THIS PRODUCT IS LICENSED UNDER THE AVC PATENT PORTFOLIO LICENSE FOR THE PERSONAL AND NONCOMMERCIAL USE OF A CONSUMER TO (I) ENCODE VIDEO IN COMPLIANCE WITH THE AVC STANDARD ("AVC VIDEO") AND/OR (II) DECODE AVC VIDEO THAT WAS ENCODED BY A CONSUMER ENGAGED IN A PERSONAL AND NON-COMMERCIAL ACTIVITY AND/OR WAS OBTAINED FROM A VIDEO PROVIDER LICENSED TO PROVIDE AVC VIDEO. NO LICENSE IS GRANTED OR SHALL BE IMPLIED FOR ANY OTHER USE. ADDITIONAL INFORMATION MAY BE OBTAINED FROM MPEG LA, L.L.C. SEE [HTTP://WWW.MPEGLA.COM](http://www.mpegla.com)

Licence Notification

TRADEMARK ACKNOWLEDGMENT



Manufactured under license from Dolby Laboratories. Dolby, Dolby Atmos, Dolby Vision, and the double-D symbol are trademarks of Dolby Laboratories. Confidential unpublished works. Copyright © 2012-2019 Dolby Laboratories. All rights reserved.

Disposal of Used Electrical & Electronic Equipment

Packaging and electrical goods should be recycled appropriately, and not treated as household waste. Please dispose of this equipment at your applicable collection point for the recycling of electrical & electronic equipment waste. By ensuring the correct disposal of this product, you will help prevent potentially hazardous to the environment and to human health, which could otherwise be caused by unsuitable waste handling of this product. The recycling of materials will help conserve natural resources. Please do not therefore dispose of your old electrical and electronic equipment with your household waste. For more detailed information about recycling of this product, please contact your local city office, your household waste disposal service or the shop where you purchased the product.

